

# OptiFlex<sup>®</sup>3

---

## **SERVICE MANUAL**



**Model- 2090**

Applies to Serial numbers 1000 and above

 **CHATTANOOGA**  
**GROUP**  
ISO 13485 CERTIFIED

# TABLE OF CONTENTS

FOREWORD.....	1
1- THEORY OF OPERATION .....	2
2- SAFETY PRECAUTIONS .....	3-5
3- NOMENCLATURE .....	6-7
4- SPECIFICATIONS .....	8-9
4.1 OPTIFLEX <sup>3</sup> CPM THERAPY UNIT SPECIFICATIONS .....	8
4.2 DESCRIPTION OF DEVICE MARKINGS .....	9
4.3 ADDITIONAL DEVICE MARKINGS .....	9
5- TROUBLESHOOTING.....	10-15
5.1 OPTIFLEX <sup>3</sup> SOFTWARE ERROR MESSAGES .....	10
5.2 OPTIFLEX <sup>3</sup> SYSTEM TESTING .....	11
5.3 VISUAL INSPECTION.....	12
5.4 FUNCTIONAL INSPECTION .....	12
5.5 ELECTRICAL SAFETY .....	12
5.6 ELECTRICAL SAFETY TESTS.....	12
5.7 FLEXION ANGLE AND CALIBRATION TEST.....	13
5.8 TRAVEL SPEED TEST.....	15
5.9 EMERGENCY START/STOP FUNCTION TEST.....	15
5.10 PENDANT DISCONNECT TEST .....	15
6- REMOVAL & REPLACEMENT.....	16-31
6.1 UNIT COVERS .....	16
6.2 MANUAL MOVEMENT OF THE CARRIAGE.....	17
6.3 MOTOR CONTROL BOARD .....	18
6.4 DRIVE BELT .....	19
6.5 MOTOR ASSEMBLY .....	20
6.6 POWER SUPPLY .....	21
6.7 POTENTIOMETER (KNEE-POT) .....	22
6.8 ACME SCREW (BALL SCREW) .....	24
6.9 PENDANT RECEPTACLE CABLE .....	26
6.10 PENDANT CABLE .....	27
6.11 PENDANT CONTROL BOARD .....	28
6.12 PENDANT BATTERY .....	29
6.13 UPPER AND LOWER PENDANT KEYMATS .....	30
6.14 PENDANT DISPLAY .....	31
7- CALIBRATION .....	32-34
7.1 ANGLE POTENTIOMETER POSITION CALIBRATION .....	32
7.2 FORCE REVERSAL CALIBRATION .....	34
8-MAINTENANCE .....	35-37
9- PARTS.....	38-40
10- SCHEMATICS.....	41-44
11- WARRANTY .....	45

Read, understand, and follow the Safety Precautions and all other information contained in this manual.

This manual contains the necessary safety and field service information for those field service technicians, certified by Chattanooga Group, to perform field service on the OptiFlex<sup>3</sup> CPM Therapy Unit.

The specifications put forth in this manual were in effect at the time of the publication. However, owing to Chattanooga Group's policy of continuous improvement, changes to these specifications may be made at any time without obligation on the part of Chattanooga Group.

Chattanooga Group requires all Field Technicians stay informed and trained on all changes pertaining to the OptiFlex<sup>3</sup> CPM Therapy Unit. As significant changes occur to the OptiFlex<sup>3</sup> CPM Therapy Unit, service bulletins may be made available on our web site ([chattgroup.com](http://chattgroup.com)) in lieu of reprinted manuals.

Technicians repairing the OptiFlex<sup>3</sup> CPM Therapy Unit agrees to assume all risk and liability associated with this process.

Due to the complex nature of the technology utilized by Chattanooga Group, the recommended troubleshooting techniques are to determine "Bad Board" and board replacement only. No board component level troubleshooting is recommended, nor will information or parts be supplied by Chattanooga Group.

## 1.1 OVERVIEW

The OptiFlex<sup>3</sup> CPM product is comprised of one Universal Power Supply and one Motor Control Board housed within the head section of the unit along with the Motor and Gearbox Assembly. These components are linked to a Pendant via a cable connection that provides the operator access for set up and operation of the unit. The basic components of the OptiFlex<sup>3</sup> CPM units are Frame Base, Motor and Gearbox Assembly, Universal Power Supply, Motor Control PC Board, Adjustable Foot Plate, Adjustable Femur Bar and User Interface (Pendant).

The unit is designed for patient use only with the Patient Softgoods Kit (Part Number 20533). This single patient use softgoods kit is designed specifically for the OptiFlex<sup>3</sup> CPM unit and provides proper installation and support to the patient during therapy.

If necessary, two units may be used simultaneously for patients that have been prescribed dual therapy by a licensed professional. If two units are prescribed for use simultaneously, use with the optional bed mount (Part Number 89900) to secure the units in position during therapy.



### 2.1 PRECAUTIONARY DEFINITIONS

The precautionary instructions found in this section and throughout this manual are indicated by specific symbols. Understand these symbols and their definitions before operating this equipment. The definition of these symbols are as follows:

#### A. Caution



Text with a "CAUTION" indicator will explain possible safety infractions that could have the potential to cause minor to moderate injury or damage to equipment.

#### B. Warning



Text with a "WARNING" indicator will explain possible safety infractions that will potentially cause serious injury and equipment damage.

#### C. Danger



Text with a "DANGER" indicator will explain possible safety infractions that are imminently hazardous situations that would result in death or serious injury.

#### D. Dangerous Voltage



Text with a "Dangerous Voltage" indicator serves to inform the technician of possible hazards resulting in the electrical charge disbursement from certain components if handled or serviced improperly.

#### E. Biohazard



Text with a "BIOHAZARD" indicator will explain possible safety infractions that could cause biohazardous conditions if the material is not properly handled and disposed of.

#### F. Note

Throughout this manual "NOTE" may be found. These Notes are helpful information to aid in the particular area or function being described.

### 2.2 PRECAUTIONARY INSTRUCTIONS

#### CAUTION

- Read, understand and practice the precautionary and operating instructions found in this manual before operating or using the unit. Know the limitations and hazards associated with using the OptiFlex<sup>3</sup> Continuous Passive Motion (CPM) Therapy Unit. Observe any and all precautionary and operational decals placed on the unit.
- Only use OptiFlex<sup>3</sup> on firm, flat, level surfaces.
- Extreme caution should be taken when in use with or around children.
- Use OptiFlex<sup>3</sup> only for its intended purpose as described in this manual.
- Turn power switch off before unplugging unit from its power source.
- Do not use the cord to unplug the power cord from the unit. Grasp at the power cord base.
- Transport and store the OptiFlex<sup>3</sup> in temperatures between 0° and 140 °F (-18° to 60 °C) to prevent damage to the unit or its components.
- Use extra care when touching metal of OptiFlex<sup>3</sup> after exposure to cold or heat to prevent static shock to persons and or the unit.
- Condensation could result and damage OptiFlex<sup>3</sup> if unit is subjected to periods of low temperatures followed by periods of high temperatures.
- Use care when carrying, transporting or storing the OptiFlex<sup>3</sup> unit to prevent damage to the unit from dropping or improper transport and storage methods.
- Keep hair, loose clothing, fingers and all parts of the body except the limb being treated, away from moving parts of the OptiFlex<sup>3</sup>.
- Unplug the Power Cord when not in use.
- Do not use Power Cords that are damaged or frayed.
- OptiFlex<sup>3</sup> is made from high impact materials. However, structural failure or hidden damage can be caused by shock, impact, or dropping the unit. Use care when transporting and storing unit to avoid equipment damage.
- To isolate the unit from the power source, disconnect the power cord at the wall outlet.
- Rapid increases in ROM can cause complications.
- Tool, lubrication, and locking compound requirements are critical to component removal and replacement of the OptiFlex<sup>3</sup>.
- All hardware, bolts, nuts, and screws used to assemble the OptiFlex<sup>3</sup> are SAE Standard. Due to the size of these components, no metric equivalent is available. Therefore, it will be necessary to obtain the proper size tools for removal and replacement of certain components.

#### CAUTION

- The lubricants and locking compounds listed in this manual are crucial in the assembly of certain components to ensure patient safety and efficient operation of the unit. Use only the recommended products listed or an approved equivalent possessing the same properties and qualities.

#### WARNING

- Federal law restricts this device to sale by, or on the order of, a physician or licensed practitioner.
- Make certain that the unit is electrically grounded by connecting only to a grounded electrical service receptacle conforming to the applicable national and local electrical codes.
- Keep hair, loose clothing, loose bedding, fingers and toes away from the hinge components of the unit.
- Do not use the OptiFlex<sup>3</sup> outdoors or on wet surfaces. Use only on firm, flat, stable level surfaces to ensure stability of the unit while in operation.
- Materials of the unit may become flammable or combustible if exposed to a source of ignition.
- Heat generated within the pendant may cause ignition of the pendant if wrapped in bedding or other materials.
- Do not use OptiFlex<sup>3</sup> while smoking or around open flame.
- OptiFlex<sup>3</sup> has been designed for protection against the exposure of urinary incontinence. Precautionary measures should still be taken when any type of liquid comes in contact with an electrical apparatus.
- Always turn off and unplug unit from electrical source before servicing or cleaning. Failure to do so could result in electrical shock or personal injury.
- Handle the unit only when unit is dry and hands are dry to prevent electrical shock.
- Do not use the OptiFlex<sup>3</sup> as a toy.
- A unit failing dielectric withstand and/or leakage tests could indicate serious internal system problems. Do not place unit back into service. Contact the factory for repair. Do not attempt to repair the unit in the field.
- Unplug the unit from the power source before attempting any removal or replacement procedures to prevent electrical shock.

### 2.2 PRECAUTIONARY INSTRUCTIONS (CONTINUED)

#### **DANGER**



- DO NOT connect the unit to an electrical supply without first verifying that the power supply is the correct voltage. Incorrect voltage may cause unit damage, malfunction, electrical shock, fire, or personal injury. Your unit was constructed to operate only on the electrical voltage specified on the Voltage Rating and Serial Number Plate. Contact your Chattanooga Group dealer if the unit is not properly rated.
- Power Supplies retain High Voltage!



- Materials that have been in contact with bodily fluids must be handled and disposed of in accordance with National, Local, and Facility disposal rules, regulations, and procedures.
- Exercise caution when using accessories and auxiliary devices such as muscle stimulators, cold packs and other modalities. Route lead wires, hoses, tubes, etc. away from the working mechanism of the OptiFlex<sup>3</sup> to help prevent damage to the OptiFlex<sup>3</sup> and any other modality used with it.
- Unconscious patients or patients under heavy influence of medication must be constantly attended and monitored while the OptiFlex<sup>3</sup> is in use.
- The OptiFlex<sup>3</sup> must be completely visible at all times during use. Never cover the unit with bedding or any other means of concealment while in operation.
- If the OptiFlex<sup>3</sup> is used in conjunction with the optional OptiFlex "T" Trolley, make certain the OptiFlex<sup>3</sup> unit is resting on the mattress of the bed and the OptiFlex "T" is suspended with no weight on the casters to prevent possible movement of the unit and possible injury to patient.
- This unit must not be operated with any adapter attached to the three prong plug that would disable the earth connection. Disruption of the earth connection may cause unit damage, malfunction, electrical shock, fire, or personal injury.

#### **DANGER**

- Failure to re-install and properly tighten all screws may result in Electrical Safety System degradation which may cause unit damage, malfunction, electrical shock or personal injury.

# 3- NOMENCLATURE

## 3.1 OPTIFLEX<sup>3</sup>

The nomenclature graphic below, Figure 3.1, indicates the general locations of the major components of the OptiFlex<sup>3</sup> CPM unit.

Know the components and their functions before performing any operation of or service to the OptiFlex<sup>3</sup> CPM unit.

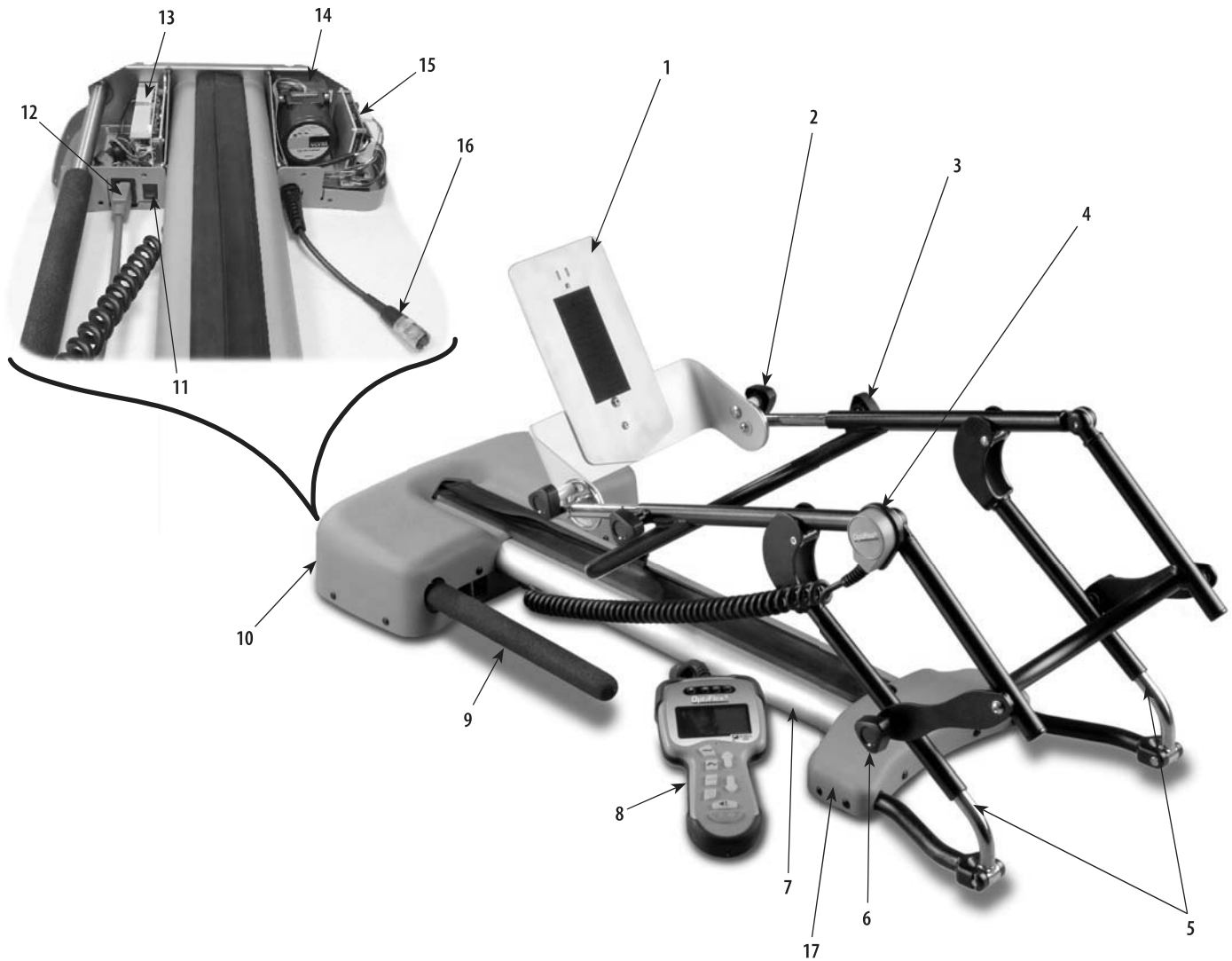

**FIGURE 3.1**

- 1. Adjustable Foot Plate
- 2. Foot Rest Pivot Adjustment
- 3. Tibial Adjustment Knob
- 4. Angle Potentiometer (Knee Pot)
- 5. Femur Bar Adjustment Scale
- 6. Femur Bar Adjustment Knob
- 7. Frame Base
- 8. Pendant (User Interface)- **Refer to Page 7**
- 9. Carrying and Storage Handle
- 10. Motor Cover
- 11. On/Off Switch
- 12. Mains Power Cord
- 13. Universal Power Supply
- 14. Motor and Gearbox Assembly
- 15. Motor Control Board
- 16. Pendant Receptacle Cable
- 17. Front Access Cover



## 3.2 OPTIFLEX<sup>3</sup> PENDANT

The Pendant nomenclature graphic below, Figure 3.2, indicates the location and functions of the OptiFlex<sup>3</sup> CPM Pendant (user interface).

Know the components and their functions before performing any operation of or service to the OptiFlex<sup>3</sup> CPM unit.



**FIGURE 3.2**

- |   |  |
|---|--|
| <p>1.  <b>OSCILLATION ZONE™</b><br/>Carriage will oscillate three times between the flexion angle and 10° less than the flexion angle.</p> <p>2.  <b>PROGRESSIVE *ROM™</b><br/>Unit will automatically increase the programmed flexion angle by 1° every hour up to a maximum of 5° per day.</p> <p>3. <b>USER INTERFACE SCREEN</b><br/>Displays settings and status of therapy session.</p> <p>4.  <b>RESET</b><br/>Clear previous treatment settings and completed cycles.</p> <p>5. <b>UP ARROW</b><br/>Allows user to increase treatment parameters.</p> <p>6. <b>DOWN ARROW</b><br/>Allows user to decrease treatment parameters.</p> <p>7.  <b>COMFORT ZONE™</b><br/>Temporarily decreases the flexion ROM* when discomfort is experienced.</p> | <p>8.  <b>EMERGENCY START/STOP</b><br/>Start or stop treatment.</p> <p>9.  <b>EXTENSION/FLEXION DELAY</b><br/>Allows user to program carriage to stop at both the extension and flexion angle for the time programmed.</p> <p>10.  <b>SPEED</b><br/>Displays the speed of operation.</p> <p>11.  <b>FLEXION</b><br/>Displays the flexion angle.</p> <p>12.  <b>EXTENSION</b><br/>Displays the extension angle.</p> <p>13.  <b>MODE</b><br/>Used with Fast Back, Oscillation Zone, and Progressive ROM*.</p> <p>14.  <b>FAST BACK™</b><br/>Carriage will slow down within 15° of the flexion angle.</p> |
|---|--|

\* ROM= Range of Motion

## 4.1 OPTIFLEX<sup>3</sup> CPM THERAPY UNIT SPECIFICATIONS



**FIGURE 4.1**

Input. . . . . 100-240 VAC, 50/60 Hz, 75 VA  
 Weight . . . . . 27 lbs (12 kg)  
 Length. . . . . 37 in (94 cm)  
 Electrical Class . . . . . Class I  
 Electrical Type. . . . . Type B   
 Mode of Operation. . . . . Continuous

**OPERATION**

Flexion . . . . . 120° Maximum  
 Extension. . . . . -10° Maximum Hyper Extension  
 Speed. . . . . 30° per min. to 150° per min  
 Maximum Patient Weight. . . . . 350 lbs (159 kg)  
 Lower Leg Length Range. . . . . 10-23.5 in (25.4- 59.7 cm)  
 (Center of knee to sole of heel)  
 Thigh Length Range . . . . . 12-19 in (30.5-48.3 cm)  
 (Hip joint to center of knee)

**TRANSPORTATION AND STORAGE REQUIREMENTS**

Unit should be transported and stored under the following conditions:  
 Temperature. . . . . 0° F to 140° F (-18° C to 60° C)  
 Humidity. . . . . 0% to 75% Relative Humidity

**REGULATORY COMPLIANCE**

UL 60601-1  
 CAN/CSA C22.2 No. 601.1-M90 w/A2  
 IEC/EN 60601-1, 60601-1-2  
 Meets MDD 93/42/EEC, CE 0413

## 4- SPECIFICATIONS

### 4.2 DESCRIPTION OF DEVICE MARKINGS

The markings on the OptiFlex<sup>3</sup> CPM unit are your assurance of its conformity to the highest applicable standards of medical equipment safety and electromagnetic compatibility. One or more of the following markings may appear on the device:



Meets Directive 93 /42 /EEC  
IEC/UL/EN 60601-1, 60601-1-2



***This product complies with WEEE Directive 2002/96/EG (waste electrical and electronic equipment). Separate collection for electrical and electronic equipment.***



Listed by Intertek Testing Services NA Inc.  
Conforms to UL Standard 60601-1  
Certified to CAN/CSA Standard C22.2 No.  
601.1-M90 w/A2



Refer to Instruction Manual/Booklet



Type B Equipment



Protected Earth

### 4.3 ADDITIONAL DEVICE MARKINGS



Emergency Stop



Standby Power ON



Standby Power OFF



Start

## 5.1 OPTIFLEX<sup>3</sup> SOFTWARE ERROR MESSAGES

**A.** The information provided below is intended to aid in troubleshooting Software Error Messages of the OptiFlex<sup>3</sup> units to “Board Level” only. No component level troubleshooting information is or will be provided by Chattanooga Group for field troubleshooting of board components.

**B.** Once a particular PCB has been determined as bad, replace the suspected board.

ERROR	ERROR DEFINITION	PROBABLE CAUSE	POSSIBLE REMEDY
1 & 2	Pendant isn't communicating correctly with unit.	Defective Cable, Pendant, or Motor Control Board.	Replace the Cable, Pendant, or Motor Control Board.
3	Error reading the EEPROM on the motor pcb.	Defective Cable, Pendant, or Motor Control Board.	Replace the Cable, Pendant, or Motor Control Board.
5	RTC battery voltage is too low indicating bad battery.	Pendant Battery voltage is low.	Replace Pendant.
6	A general error on the motor pcb has occurred.	Motor Control Board Failure.	Replace the Motor Control Board.
7	The Angle Potentiometer sensor is out of range.	Carriage angle below -10° limit.	Loosen the Femur Adjustment Knobs. Raise the carriage to above zero and tighten the Femur Adjustment Knobs. Turn the unit off and back on with the power switch.
8	The Angle Potentiometer is not changing when the carriage is supposed to be moving.	Carriage obstruction or the Angle Pot Screw is loose. Femur Knobs loose.	Remove the obstruction. Tighten the Angle Potentiometer Screw and Calibrate unit. Tighten Femur Knobs
9	The motor tachometer does not match expected value.	Motor Control Board Failure.	Replace the Motor Control Board.
10	The motor pcb has not communicated with the pendant in a reasonable amount of time.	Motor Control Board Failure.	Replace the Motor Control Board.
11	The motor pcb was reset via the watchdog.	Motor Control Board Failure.	Replace the Motor Control Board.
	Unit needs to be calibrated.	Various	Calibrate unit. Refer to <b>pages 32-34</b> for calibration procedures.

## 5.2 OPTIFLEX<sup>3</sup> SYSTEM TESTING

### A. General

1. The following information is intended to aid in troubleshooting the major components of the OptiFlex<sup>3</sup> units to “Board Level” only. These tests are OEM standard testing procedures and methods used at the factory before shipment of any OptiFlex<sup>3</sup> unit.
2. Due to the complex nature of the technology utilized by Chattanooga Group, the recommended troubleshooting techniques are to determine “Bad Board” and board replacement only. No board component level troubleshooting is recommended nor will information or parts be supplied by Chattanooga Group. Any board component level troubleshooting performed will be at sole risk and liability of the Service Technician performing such troubleshooting techniques.
3. Once a particular PC Board has been determined to be bad, replace the board only with Chattanooga Group OEM replacement parts and hardware.

### B. Special Tools, Fixtures, and Materials Required

1. Certain tests require the use of special tools and fixtures. These will be listed at the particular test where they are required. Testing with any other special tool or fixture other than those stated could give erroneous readings or test results. Always perform the tests exactly as stated to ensure accurate results.
2. Standard test equipment settings will be listed for each test performed to aid in performing the test to OEM standards and to ensure proper readings.
3. The troubleshooting and repair of the OptiFlex<sup>3</sup> units should be performed only by authorized technicians trained and certified by Chattanooga Group.

### C. Equipment Required

1. Digital Multimeter
2. Fine Edged Tool for removing decals
3. Tape Measure or Ruler

## CAUTION

The following tool, lubrication, and locking compound requirements are critical to component removal and replacement of the OptiFlex<sup>3</sup>.

All hardware, bolts, nuts, and screws used to assemble the OptiFlex<sup>3</sup> are SAE Standard. Due to the size of these components, no metric equivalent is available. Therefore, it will be necessary to obtain the proper size tools for removal and replacement of certain components.

The lubricants and locking compounds listed in this manual are crucial in the assembly of certain components to ensure patient safety and efficient operation of the unit. Use only the recommended products listed or an approved equivalent possessing the same properties and qualities.

### 4. Required SAE Tools

- #1 Phillips Screwdriver
- #2 Phillips Screwdriver
- Preset and calibrated, 5 inch pound “T”-Handle Torque Wrench with 1/4” square drive and 5/64” straight hex key socket
- Preset and calibrated, 10 inch pound “T”-Handle Torque Wrench with 1/4” square drive and 9/64” straight hex key socket
- 5/16” Socket Driver
- 3/32” Allen Wrench

### 5. Required Lubricants

- MolyGraph Grease (Black) by Sta-Lube

### 6. Required Locking Compound and Primer

- Type N Primer by Loctite
- Loctite 222 (Purple)
- Loctite 242 (Blue)
- Loctite 262 (Red)

### 7. Inclinator, Protractor, or Goniometer accurate to 1°

### 8. Certified, calibrated Stop Watch

#### NOTE:

The tool, lubricant, and locking compound requirements will be listed at their respective removal and replacement procedures throughout this manual.

## 5.3 VISUAL INSPECTION

### A. General

Visually inspect the OptiFlex<sup>3</sup> for and visible damage to the unit or pendant that may interfere with operation of the unit. Make sure that all screws are secure. Verify that the appropriate hook or loop fastener is secured to the carriage.

Check for proper labeling. Make sure that the Femur adjustment decals are in good condition. Verify that the serial decal for the unit is present.

Verify that the LCD lens is in good condition and clean if necessary.

Verify that the domed heads of the femur hinge rivets are in good condition. Make sure that the hinges are secure, by attempting to pull them apart.

## 5.4 FUNCTIONAL INSPECTION

Check the calibration of the unit by running it successively through its full ROM with femur length adjusted first to maximum and then to its minimum length.

### NOTE:

Verify that the lead screw is unobstructed and no abnormal noises are present during operation.

Pull out the pendant while the unit is running to verify that the unit will stop.

Perform the Speed test found on **page 15**.

Activating the New Patient Reset clears all settings.

## 5.5 ELECTRICAL SAFETY

The OptiFlex<sup>3</sup> has been tested to UL 60601-1, Standard for Safety for Medical Equipment.

### NOTE:

The device complies with current leakage, ground continuity, and dielectric withstand (Hi-Pot) limits as prescribed by IEC/EN/UL 60601-1 and C22.2 No. 601.1-M90 w/A2 Medical Electrical, Part 1: General Requirements for Safety.

Facility, local and national limits and test methods may vary.

### A. Power Requirements

Model: 2090 .....Input: 100-240 VAC  
50/60 HZ, 75 VA

## 5.6 ELECTRICAL SAFETY TESTS

Conduct all necessary Electrical Safety tests as required per your facility, local or national regulatory agency. In the USA follow NFPA 99 (National Fire Protection Association) "Health care Facility" standards.

### **WARNING**

A unit failing dielectric withstand and/or leakage tests could indicate serious internal system problems. Do not place unit back into service. Contact the factory for repair. Do not attempt to repair the unit in the field.

### **DANGER**



This unit must not be operated with any adapter attached to the three prong plug that would disable the earth connection. Disruption of the earth connection may cause unit damage, malfunction, electrical shock, fire, or personal injury.

## 5.7 FLEXION ANGLE & CALIBRATION TEST

Specification .....90° ± 3°

### A. Equipment Required

Inclinometer, Protractor, or Goniometer accurate to 1°.

### B. Test

1. Place unit on level work surface.
2. Plug Power Cord into grounded wall outlet with appropriate voltage. See Specifications on **page 8**.
3. Connect Pendant to unit and turn unit power ON.
4. Press and hold the Extension button. While holding the Extension button down, press the Down Arrow button until 0 is displayed on the Pendant. **Refer to Figure 5.1.**

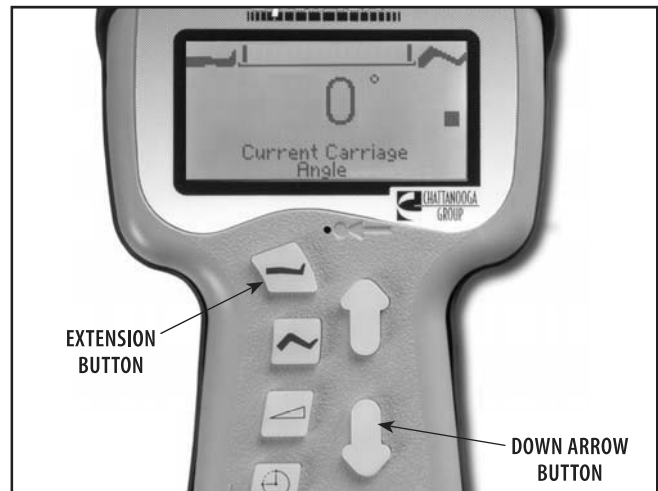

**FIGURE 5.1**

5. Press and hold the Time and Extension buttons. While holding the Time and Extension buttons, press the Up or Down Arrow button until 5 Sec is displayed on the Pendant. **Refer to Figure 5.2.**

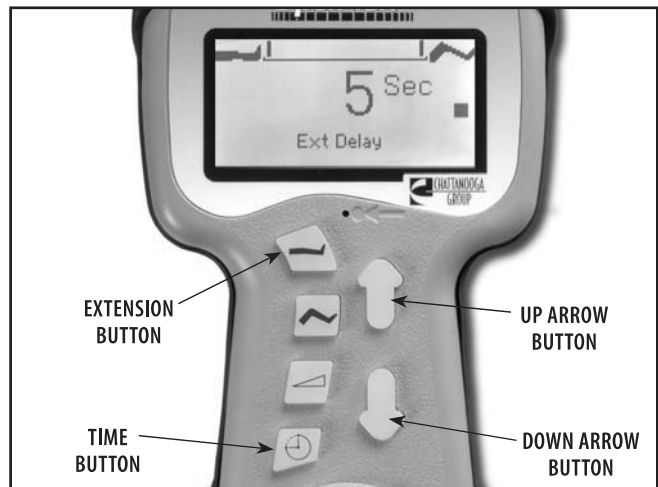

**FIGURE 5.2**

6. Press and hold the Time and Flexion buttons. While holding the Time and Flexion buttons, press the Up or Down Arrow button until 5 Sec is displayed on the Pendant. **Refer to Figure 5.3.**

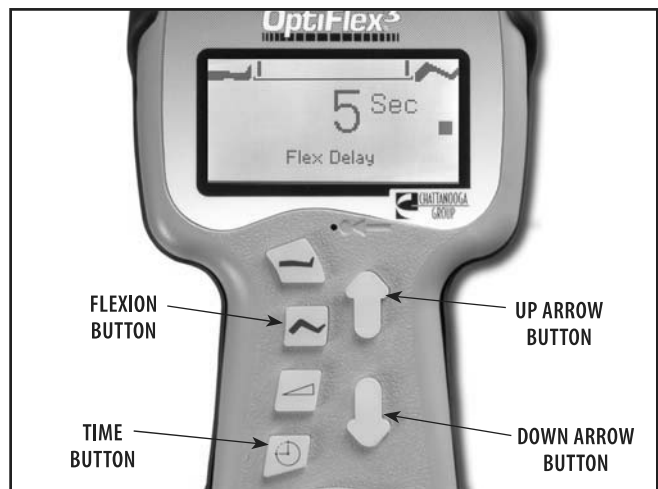

**FIGURE 5.3**

7. Press and hold the Flexion button. While holding the Flexion button down, press the Up Arrow button until 90° is displayed on the Pendant. **Refer to Figure 5.4.**



**FIGURE 5.4**

8. Press and hold the Speed button. While holding the Speed button down, press the Up or Down Arrow button until 90° /Min is displayed on the Pendant. **Refer to Figure 5.5.**
9. While continuing to hold the Speed Button, press the Emergency Start/Stop button on the Pendant. When movement of the unit stops, press the Emergency Start/Stop button. Verify the display reads 90° /Min.



**FIGURE 5.5**

10. Using the Inclinator or Protractor, measure the angle of the flexion of the unit. **Refer to Figure 5.6.**

**NOTE:**

In **Figure 5.6**, a Digital Inclinator is used to measure each side and the two numbers are added together.

If angle is out of specified range, perform **7.1 Angle Potentiometer Position Calibration.**

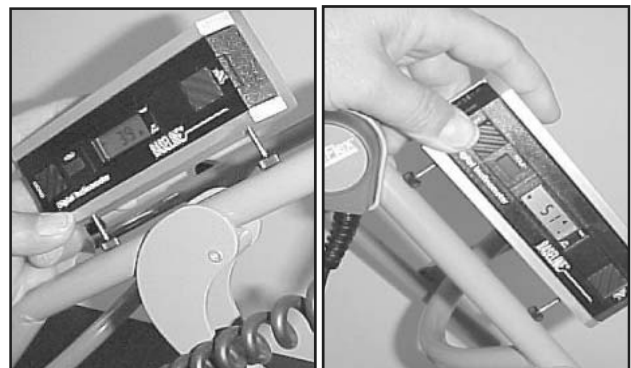

**FIGURE 5.6**



## 5.8 TRAVEL SPEED TEST

**Spec** ..... 0° to 90° in 60 Sec ±10%  
of seconds

### A. Equipment Required

Calibrated stop watch

### B. Test

1. Set unit up as described in the "Flexion Angle Test."
2. Adjust the Fermur Bar length to 34 and tighten.
2. Move to 0° by pressing the Emergency Start/Stop button. When motion stops and Display reads 0°, press the Emergency Start/Stop button to stop the unit. Then, simultaneously press the Emergency Start/Stop button and the stop watch start button. The unit should move from 0° to 90° within the specification listed above.
3. Repeat three times. Calculate and Record the average.
4. If unit fails test, troubleshoot the following components and replace if necessary:
  - a. Check Pendant Cable connector to Motor Control Board
  - b. Motor Control Board
  - c. Pendant
  - d. Motor Assembly
  - e. Drive Belt
  - f. Pulleys

## 5.9 EMERGENCY START/STOP FUNCTION TEST

**Spec** ..... Unit start or stop upon pushing button

### A. Equipment Required

OptiFlex<sup>3</sup> with Pendant

### B. Test

1. Place unit on a level work surface.
2. Plug unit power cord into grounded wall outlet with appropriate voltage. See Specifications on **page 8**.
3. Connect Pendant to unit and turn unit power ON.
4. Press the Emergency Start/Stop button to start and stop the unit. Repeat several times.
5. If unit fails test, troubleshoot the following components and replace if necessary:
  - a. Pendant Cable connector to Motor Control Board.

b. Motor Control Board.

c. Pendant.

## 5.10 PENDANT DISCONNECT TEST

**Spec** ..... Unit stops immediately upon Pendant disconnect

### A. Equipment Required

OptiFlex<sup>3</sup> with Pendant

### B. Test

1. Place unit on a level work surface.
2. Plug unit power cord into grounded wall outlet with appropriate voltage. See Specifications on **page 8**.
3. Connect Pendant to unit and turn unit power ON.
4. Press the Emergency Start/Stop button to start the unit.
5. Disconnect the Pendant from the unit while moving. Unit should stop.
6. If unit fails test, troubleshoot the following components and replace if necessary:
  - a. Pendant Cable connector to Motor Control Board
  - b. Motor Control Board
  - c. Pendant

## 6.1 UNIT COVERS

### **WARNING**

Unplug the unit from the power source before attempting any removal or replacement procedures to prevent electrical shock.

#### A. Part Number

Push Rivet (Male & Female Components) . . . J6004  
Rear Cover. . . . . J6089  
Front Access Cover. . . . . J6103

#### B. Tools and Equipment Required

- Miniature Diagonal Cutters

#### C. Rear Cover Removal and Replacement

##### NOTE:

Miniature Diagonal Cutter are used only to remove the Rivets. They are not intended to cut the Rivets. Only apply enough pressure to grasp the Rivet. They will be used to re-install the Cover.

##### NOTE:

If Carriage is close to full extension, there may not be sufficient clearance to remove the Cover. For inoperable units, **refer to Section 6.2 Manual Movement of the Carriage** for carriage adjustment.

1. Using a pair of miniature diagonal cutters remove the 11 Rivets securing the Rear or Motor Cover. Grasp the Rivets from behind and gently pry the Rivets up to release. This will release both the male and female parts of the Rivet. **Refer to Figure 6.1.**



**FIGURE 6.1**

2. Lift up and rotate the Motor Cover toward the Carrying Handle of the unit. Slide the cover over the Carrying Handle to completely remove from the unit.

3. To install the Rear Cover, reverse the above steps.

#### D. Front Access Cover Removal and Replacement

##### NOTE:

Miniature Diagonal Cutter are used only to remove the Rivets. They are not intended to cut the Rivets. Only apply enough pressure to grasp the Rivet. They will be used to re-install the Cover.

##### NOTE:

If Carriage is close to full extension, there may not be sufficient clearance to remove the Cover. For inoperable units, **refer to Section 6.2 Manual Movement of the Carriage** for carriage adjustment.

1. Using a pair of miniature diagonal cutters remove the 8 Rivets securing the Rear or Motor Cover. Grasp the Rivets from behind and gently pry the Rivets up to release. This will release both the male and female parts of the Rivet.
2. Lift to remove.
3. Reverse above steps to install.

## 6- REMOVAL & REPLACEMENT

---

### 6.2 MANUAL MOVEMENT OF THE CARRIAGE



## WARNING

Unplug the unit from the power source before attempting any removal or replacement procedures to prevent electrical shock.

When the unit fails electronically the carriage can be moved manually.

**A. Part Number** .....None

#### **B. Tools and Equipment Required**

- Miniature Diagonal Cutters

#### **C. Manual Carriage Adjustment**

1. Refer to **Section 6.1, part C, Rear Cover Removal and Replacement** to remove the rivets from the Rear Cover of the unit.
2. Lift the bottom of the Rear Cover just enough to be able to manipulate the Pulley. Rotate the Pulley, moving the Carriage until the Cover can be completely removed.

## 6.3 MOTOR CONTROL BOARD

### **WARNING**

Unplug the unit from the power source before attempting any removal or replacement procedures to prevent electrical shock.

**A. Part Number** .....J6088

#### **B. Tools and Equipment Required**

- #2 Phillips Screwdriver

#### **C. Control Removal & Replacement**

1. Refer to **Section 6.1, part C**, Rear Cover Removal and Replacement to remove the rear cover of the unit.
2. Disconnect the four wiring harnesses from the Control Board. **Refer to Figure 6.2.**

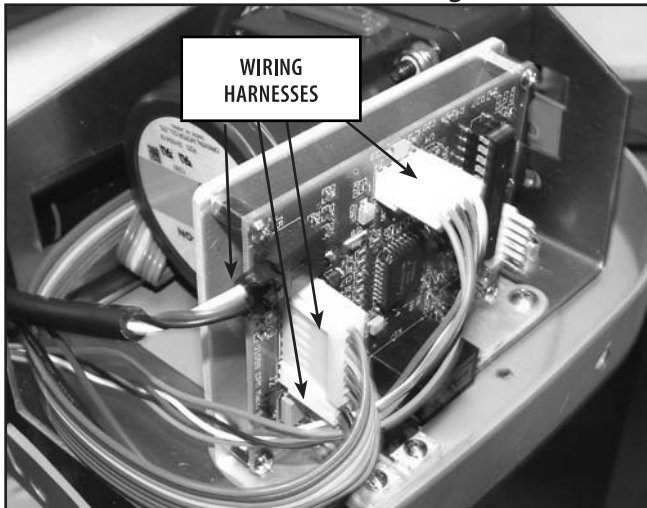

**FIGURE 6.2**

3. Using the #2 Phillips Screwdriver, remove the two mounting screws securing the Motor Control Board to the Base. **Refer to Figure 6.3.**

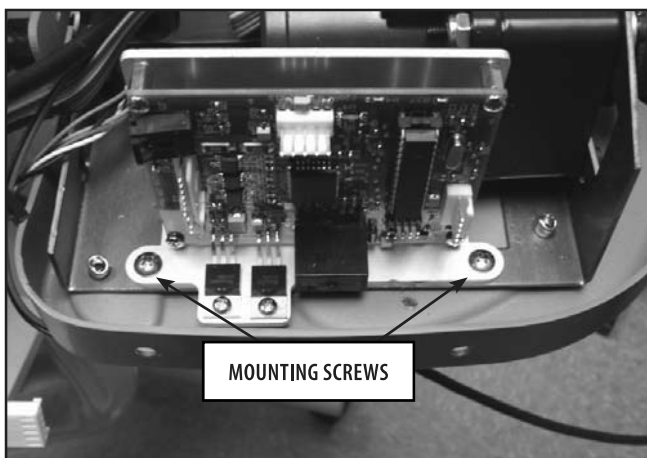

**FIGURE 6.3**

4. Replace in reverse order.

#### **NOTE:**

When connecting harnesses, each harness will connect only to their respective locations on the board.

5. After Motor Control Board replacement perform the following in the order listed:
  - 7.1 Angle Potentiometer Position Calibration
  - 5.7 Flexion Angle and Calibration Test
  - 7.2 Force Reversal Calibration
  - 5.4 Functional Inspection

### **DANGER**



Failure to re-install and properly tighten all screws may result in Electrical Safety System degradation which may cause unit damage, malfunction, electrical shock or personal injury.

## 6.4 DRIVE BELT

### **WARNING**

Unplug the unit from the power source before attempting any removal or replacement procedures to prevent electrical shock.

### **DANGER**



Failure to re-install and properly tighten all screws may result in Electrical Safety System degradation which may cause unit damage, malfunction, electrical shock or personal injury.

**A. Part Number** .....J2000

#### **B. Tools and Equipment Required**

- #2 Phillips Screwdriver
- 9/64" Allen Wrench
- Preset 10 inch-pound "T"-Handle Torque Wrench and 9/64" Hex Key Socket

#### **C. Drive Belt Removal & Replacement**

1. Refer to **Section 6.1, part C**, Rear Cover Removal and Replacement to remove the rear cover of the unit.
2. Using a 9/16" Allen wrench loosen the three motor mounting screws. **Refer to Figure 6.4.**

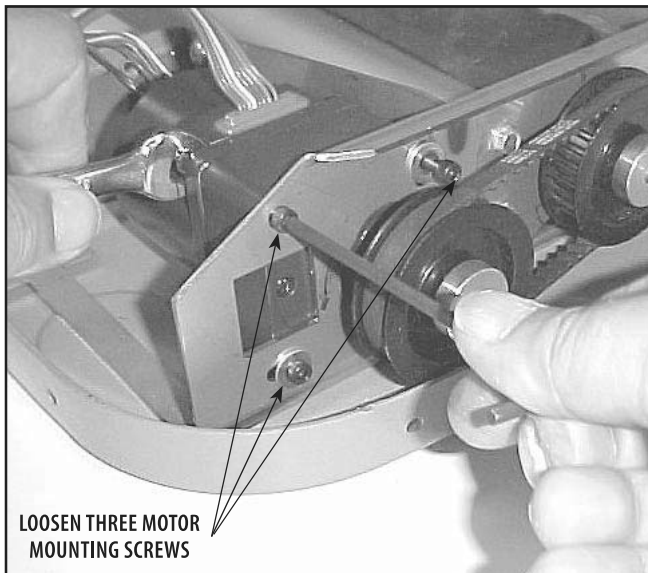

**FIGURE 6.4**

3. Remove the old belt from the pulleys.
4. Replace Drive Belt in reverse order.

#### **NOTE:**

When replacing the Drive Belt, rotate Motor by hand, applying tension to the belt. Make certain the Belt is seated into the Pulley teeth.

Torque Motor Mounting screws using the Preset 10 inch-pound "T"-Handle Torque wrench with 9/64" straight hex key socket.

Check the tension on the Drive Belt. A properly installed Belt should exhibit between 1/16" and 1/8" deflection when pressed.

## 6.5 MOTOR ASSEMBLY

### **WARNING**

Unplug the unit from the power source before attempting any removal or replacement procedures to prevent electrical shock.

**A. Part Number** ..... J2054

#### **B. Tools and Equipment Required**

- 11/32" Open End Wrench
- #2 Phillips Screwdriver
- 5/64" Allen Wrench
- 9/64" Allen Wrench
- 3/32" Allen Wrench
- Preset 10 inch-pound "T"-Handle Torque Wrench
- Preset 5 inch-pound "T"-Handle Torque Wrench
- Type N locking compound primer
- Loctite 222 (Purple) or approved equivalent
- Molykote or approved equivalent grease
- Gear Puller

#### **C. Motor Removal & Replacement**

1. Refer to **Section 6.1, part C**, Rear Cover Removal and Replacement to remove the rear cover of the unit.
2. Refer to **Section 6.3, part C**, Control Board Removal and Replacement, to remove the Control Board.
3. Refer to **Section 6.4, part C**, Drive Belt Removal and Replacement, to remove the Drive Belt.
4. Using a 5/64" Allen wrench, remove the set screw from the Motor Pulley. **Refer to Figure 6.5.**

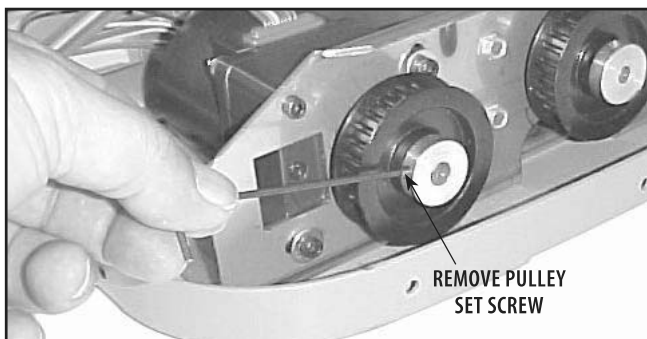

**FIGURE 6.5**

### **DANGER**

 Failure to re-install and properly tighten all screws may result in Electrical Safety System degradation which may cause unit damage, malfunction, electrical shock or personal injury.

5. Use a gear pullers remove the Pulley from the Motor shaft.

#### **NOTE:**

Using gear puller should decrease the possibility of damage to the Pulley.

6. Remove the three motor mounting screws using the 9/64" Allen wrench and remove Motor from unit. **Refer to Figure 6.6.**

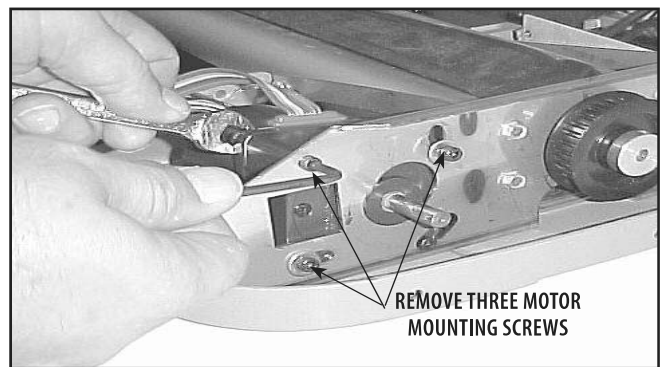

**FIGURE 6.6**

7. Install the Motor with ribbon cable up. Install the three motor mounting screws and Nylon Lock nuts. Do not completely tighten.
8. Position the Pulley onto the Motor shaft. Make certain the set screw hole is aligned with the flat area of the shaft.
9. Push the Pulley onto the shaft until the face of the Pulley collar is flush with the end of the Motor shaft.
10. Prime the Pulley set screw with the Type N primer and apply the Loctite 222 or approved equivalent per the manufacturer's instructions to the threads of the set screw.
11. Install the set screw until seated against Motor shaft and then torque using the Preset 5 inch-pound "T"-Handle Torque wrench with 5/64" straight hex key socket.
12. Refer to **Section 6.4, part C**, Drive Belt Removal and Replacement, to install the Drive Belt.
13. Refer to **Section 6.3, part C**, Control Board Removal and Replacement, to install the Control Board.
14. Refer to **Section 6.1, part C**, Rear Cover Removal and Replacement to install the Rear Cover of the unit

## 6.6 POWER SUPPLY

### **WARNING**

Unplug the unit from the power source before attempting any removal or replacement procedures to prevent electrical shock.

**A. Part Number.** ..... 21267

### **B. Tools and Equipment Required**

- Needle Nose Pliers
- #2 Phillips Screwdriver

### **C. Power Supply Removal & Replacement**

1. Refer to **Section 6.1, part C**, Rear Cover Removal and Replacement to remove the Rear Cover of the unit.
2. Disconnect the 2 pin Power Harness from the Power Supply Extension Harness. **Refer to Figure 6.7.**

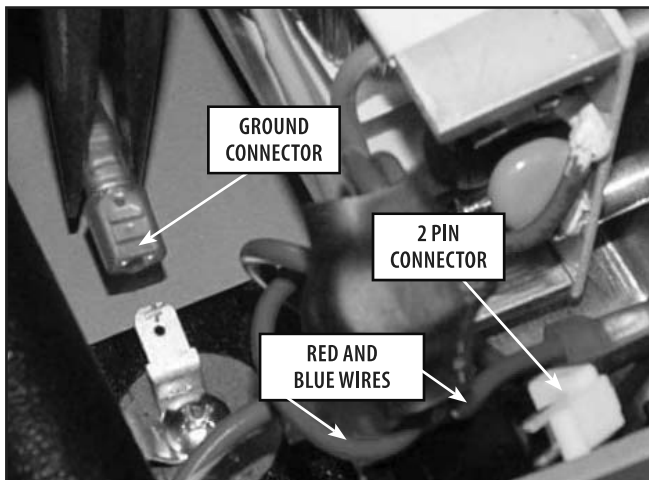

**FIGURE 6.7**

3. Using Needle Nose pliers, disconnect the ground wire. **Refer to Figure 6.7.**
4. Using Needle Nose pliers disconnect the red wire from the Rocker Switch and the blue wire from the IEC Connector. **Refer to Figure 6.7.**

6. Remove the two screws securing the Power Supply to the Base using a #2 Phillips screwdriver. **Refer to Figure 6.8.**
7. Reverse for installation.

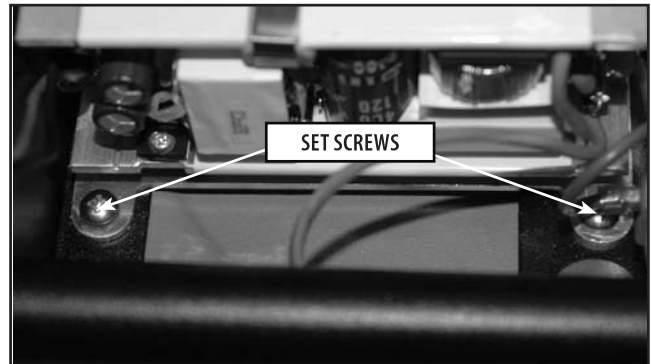

**FIGURE 6.8**

### **DANGER**



Failure to re-install and properly tighten all screws may result in Electrical Safety System degradation which may cause unit damage, malfunction, electrical shock or personal injury.

# 6- REMOVAL & REPLACEMENT

## 6.7 POTENTIOMETER (KNEE-POT)

### **WARNING**

Unplug the unit from the power source before attempting any removal or replacement procedures to prevent electrical shock.

**NOTE:**

To order a replacement Potentiometer, order all three parts listed in **section A**.

**A. Part Numbers**

- Potentiometer..... J6040
- Split Pin ..... J6023
- Nylon Covers..... J6022

**B. Tools and Equipment Required**

- 3/32" Allen Wrench
- #2 Phillips Screwdriver
- Heyco Tool

**C. Potentiometer Removal & Replacement**

1. Refer to **Section 6.1, parts C and D**, Rear Cover and Front Cover Removal and Replacement to remove the Covers of the unit.
2. Use a fine edged tool to lift the Decal on the Potentiometer and remove. **Refer to Figure 6.9.**

**NOTE:**

Save the Decal, J6107, for installation of the replacement Potentiometer.

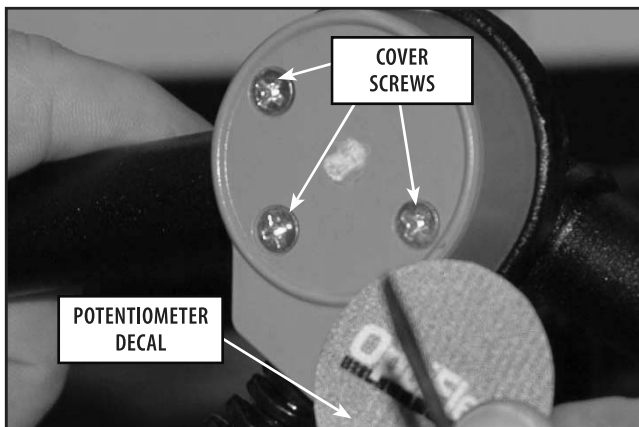

**FIGURE 6.9**

### **DANGER**

 Failure to re-install and properly tighten all screws may result in Electrical Safety System degradation which may cause unit damage, malfunction, electrical shock or personal injury.

3. Use a #2 Phillips screwdriver to remove the 3 screws securing the Potentiometer Cover and remove the Cover.

**NOTE:**

When installing the Potentiometer Cover, part number J6105, hand tighten the three screws until snug. Overtightening the screws will crack the Cover.

4. Using a 3/32" Allen wrench remove the cleat screw. **Refer to Figure 6.10**

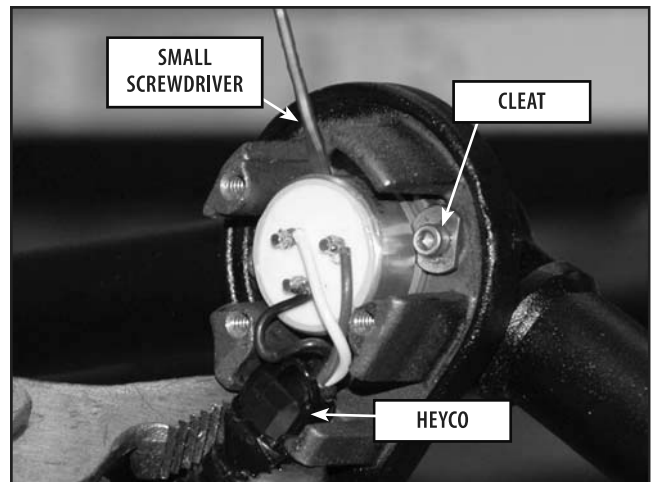

**FIGURE 6.10**

5. Using a Heyco Tool, squeeze the sides of the Heyco and pull out to remove. **Refer to Figure 6.10.**
6. Using a small Flathead screwdriver positioned behind the Potentiometer, apply just enough pressure to free the Potentiometer. **Refer to Figure 6.10.**

**NOTE:**

On the back of the Potentiometer, make certain that the Nylon Covers, part number J2022, on each side of the split pin are installed. **Refer to Figure 6.11**



**FIGURE 6.11**



## 6- REMOVAL & REPLACEMENT

---

### 6.7 POTENTIOMETER (CONTINUED)

7. On the front end of the unit, press the tab on the connector attaching the Potentiometer to the Control Board and detach.
8. Turn the unit over and using a Heyco Tool, remove the Heyco securing the Potentiometer Cable to the Base. Slide the cable wire through the Base to release.
9. Install the replacement Potentiometer by reversing **steps 4-8**. When **step 8** is complete, refer to **section 7.1 Angle Potentiometer Position Calibration**. Perform the calibration. Once the calibration is done, complete the installation by reversing **steps 1-5**.

# 6- REMOVAL & REPLACEMENT

## 6.8 ACME ROD (BALL SCREW)

### **WARNING**

Unplug the unit from the power source before attempting any removal or replacement procedures to prevent electrical shock.

**A. Part Number** ..... J2004

### **B. Tools and Equipment Required**

- Adjustable Pliers
- 5/64" Allen wrench
- #2 Phillips screwdriver
- Gear Puller
- Snap Ring Pliers
- 5/16" Nut Driver
- Large Flathead Screwdriver

### **C. Acme Rod Removal & Replacement**

1. Refer to **Section 6.1, parts C and D**, Rear Cover and Front Cover Removal and Replacement to remove the Covers of the unit.
2. Refer to **Section 6.4, part C**, Drive Belt Removal and Replacement, to remove the Drive Belt.
3. Using a 5/64" Allen wrench, remove the set screw from the Pulley attached to the Ball Screw.

#### **NOTE:**

Retain all rivets, nuts, washers, bearing and screws for installation of the Ball Screw.

4. Use a gear puller to remove the Pulley from the Ball Screw.

#### **NOTE:**

Using a gear puller will decrease the possibility of damage to the Pulley.

5. Remove the 2 washers and the bearing from the end of the Ball Screw. **Refer to Figure 6.12.**

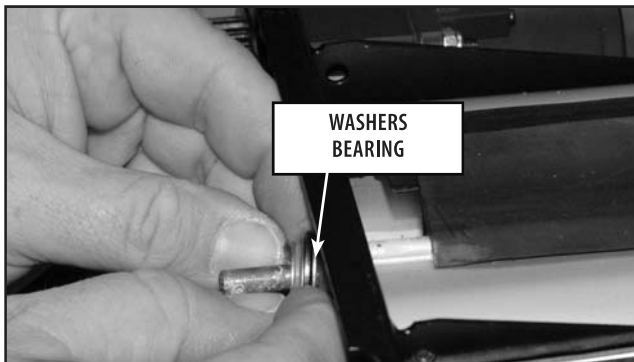
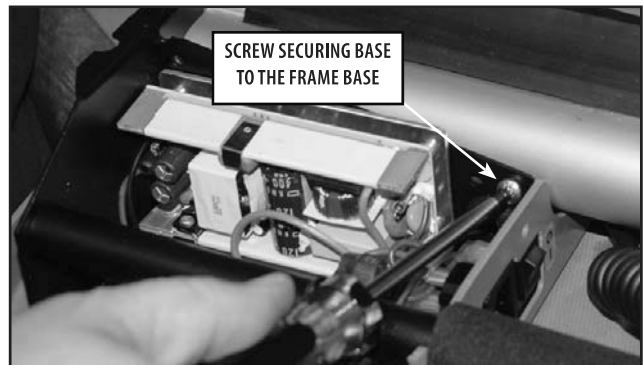

**FIGURE 6.12**

#### **NOTE:**

Observe the locations of the washers and bearing for installation. **Inset A on page 38** details proper installation.

6. Using a #2 Phillips screwdriver, remove the screw on each side of the Frame Base to release the Base. **Refer to Figure 6.13.**



**FIGURE 6.13**

7. Using a 5/16" nut driver remove the 4 nuts and washers securing the Base Plate at the end of the Frame Base. **Refer to Figure 6.14.**

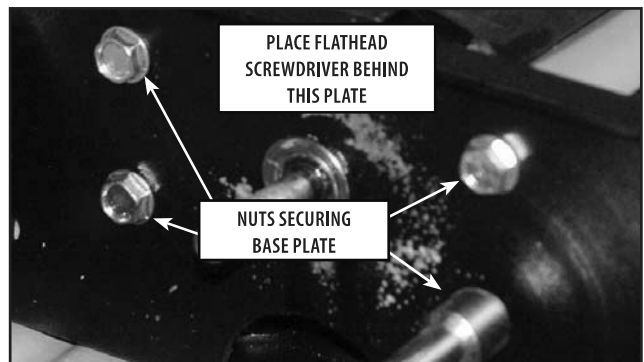

**FIGURE 6.14**

8. Using a large Flathead screwdriver, gently pry the plate off of the Ball Screw. **Refer to Figure 6.14.**

### **DANGER**



Failure to re-install and properly tighten all screws may result in Electrical Safety System degradation which may cause unit damage, malfunction, electrical shock or personal injury.

## 6- REMOVAL & REPLACEMENT

### 6.8 ACME ROD (CONTINUED)

9. Remove both of the Wiper Blades by sliding out of the open end of the Frame Base.
10. On the front end of the unit, loosen the Femur Knobs and raise the Femur Bars to full Frame Base and tighten. **Refer to Figure 6.15.**

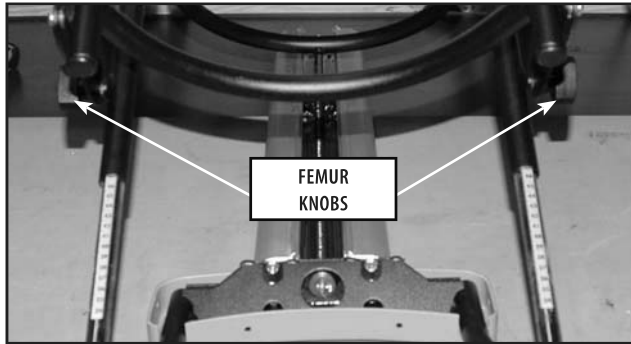
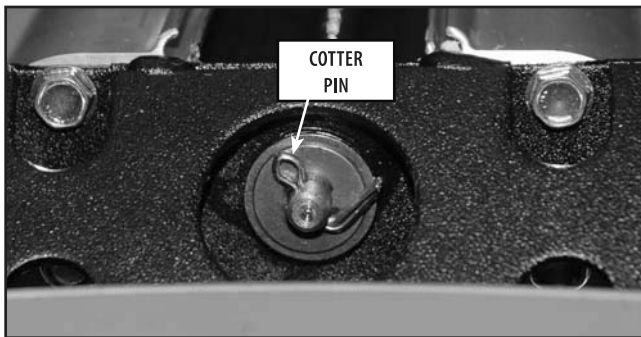

**FIGURE 6.15**

**NOTE:**

Cotter Pins are not supplied with the replacement Acme Rod. Carefully remove the Cotter Pin and retain for installation of the Ball Screw. **Refer to Figure 6.16.**

11. Remove the Cotter Pin securing the Ball Screw to the front end of the unit. **Refer to Figure 6.16.**



**FIGURE 6.16**

12. Remove the steel washer and the bearing by using a Phillips screwdriver to push the shaft of the Ball Screw through the Front Plate.

**NOTE:**

**Inset B on page 38** details proper installation of the washers and bearing.

13. Slide the Carriage to the front end of the Frame Base.

14. Using Snap Ring pliers, remove the snap ring inside of the Frame Base to release the Ball Screw. **Refer to Figure 6.17.**

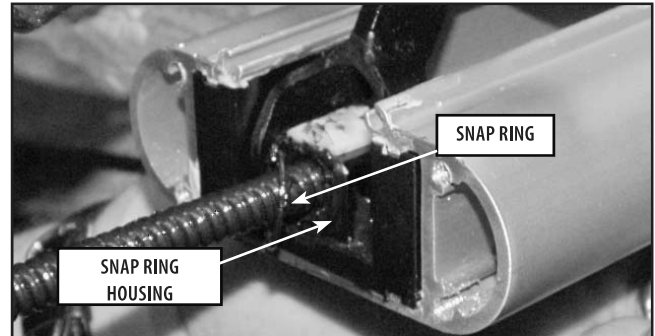

**FIGURE 6.17**

15. Pull out the Ball Screw.
16. Reverse for installation.

**NOTE:**

After installing the replacement Ball Screw and prior to installing the Wipers, coat the Screw with MolyGraph Grease (Black) by Sta-Lube.

# 6- REMOVAL & REPLACEMENT

## 6.9 PENDANT RECEPTACLE CABLE

### WARNING

Unplug the unit from the power source before attempting any removal or replacement procedures to prevent electrical shock.

**A. Part Number** .....89852

**B. Tools and Equipment Required**

- Adjustable Pliers

**C. Pendant Receptacle Cable Removal & Replacement**

1. Refer to **Section 6.1, part C**, Rear Cover Removal and Replacement to remove the Rear Cover of the unit.
2. Disconnect the Pendant Cable from the Pendant Cable Receptacle by turning the Pendant Cable connector counterclockwise. Continue to unscrew to release. **Refer to Figure 6.18.**

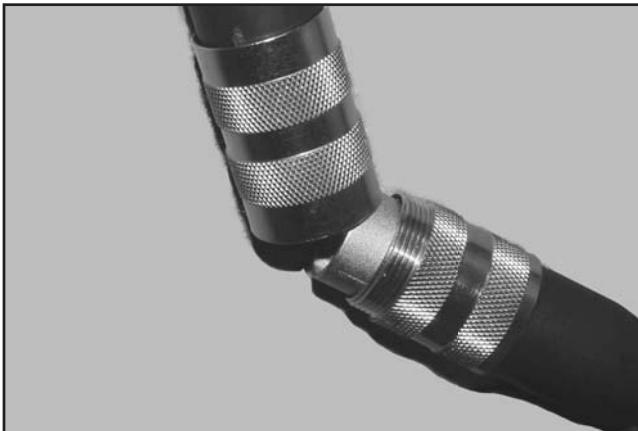

**FIGURE 6.18**

3. Hold the nut inside of the unit Frame securing the Receptacle Cable. Using a pair of adjustable pliers, turn the housing on the outside of the unit counterclockwise to release. Continue to unscrew and remove the Receptacle Cable. **Refer to Figure 6.19.**

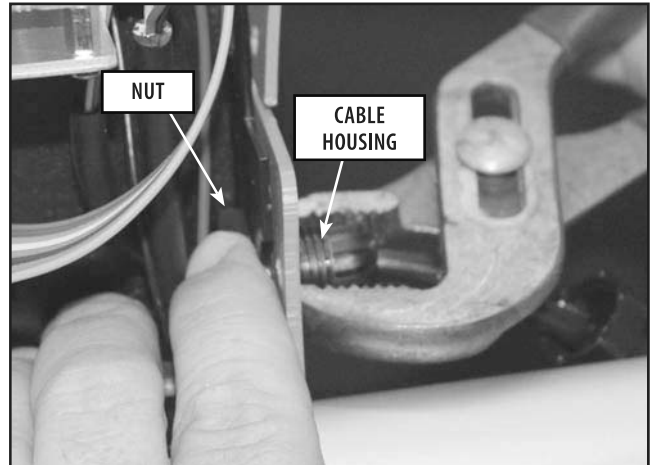

**FIGURE 6.19**

4. Disconnect the 5 pin connector from the Control Board. **Refer to Figure 6.20.**

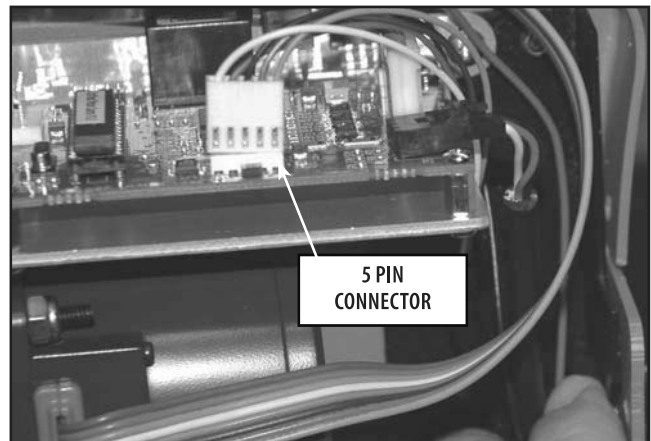

**FIGURE 6.20**

5. Replace in reverse order.

## 6- REMOVAL & REPLACEMENT

### 6.10 PENDANT CABLE

#### WARNING

Unplug the unit from the power source before attempting any removal or replacement procedures to prevent electrical shock.

**A. Part Number** ..... J6086

#### **B. Tools and Equipment Required**

- #1 Phillips Screwdriver

#### **C. Pendant Cable Removal & Replacement**

1. Disconnect the Pendant Cable from the Pendant Cable Receptacle by turning the Pendant Cable connector counterclockwise. Continue to unscrew to release.
2. Turn the Pendant face down. Using a #1 Phillips screwdriver, loosen the 7 screws securing the back Cover of the Pendant. **Refer to Figure 6.21.**

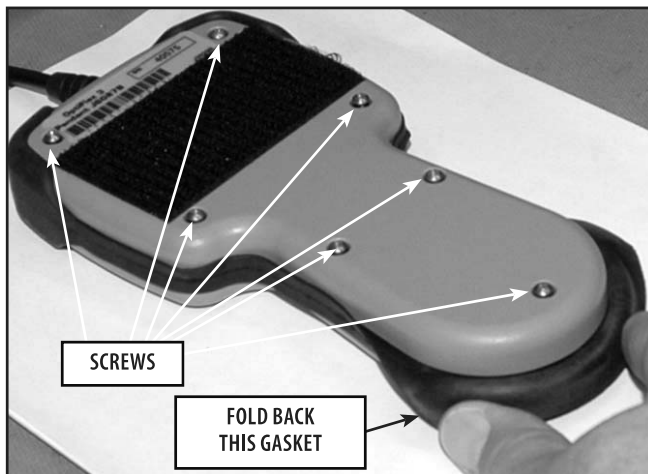

**FIGURE 6.21**

#### **NOTE:**

The part number for the screws securing the back of the pendant is J1120. The O-ring is part number J1121.

3. Fold the Rubber Gasket on the handle of the Pendant and lift the back Cover off to remove.

4. Detach the 5 pin connector from the Control Board of the Pendant. **Refer to Figure 6.22.**

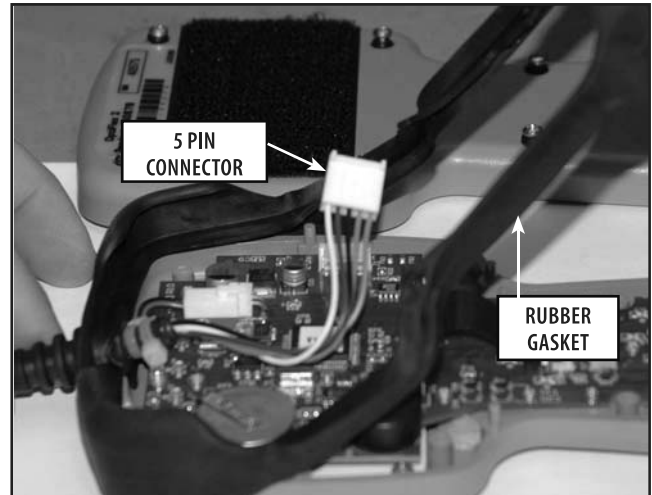

**FIGURE 6.22**

5. Lift the Rubber Gasket and pull to release the Gasket and the Cable from the base of the Pendant.
6. Replace in reverse order.

# 6- REMOVAL & REPLACEMENT

## 6.11 PENDANT CONTROL BOARD

### **WARNING**

Unplug the unit from the power source before attempting any removal or replacement procedures to prevent electrical shock.

**A. Part Number** ..... J1102

**B. Tools and Equipment Required**

- #1 Phillips Screwdriver

**C. Pendant Control Board Removal & Replacement**

1. Refer to **Section 6.10, part C, Pendant Cable Removal and Replacement** to open the Pendant and remove the Cable.
2. Using a finger nail, lift the brown plastic bar securing the Display Ribbon Cable to the Control Board. Slide the Ribbon Cable back to free from the Control Board. **Refer to Figure 6.23.**

**NOTE:**

Carefully slide the Display Ribbon Cable through the slot in the Control Board when removing the board. Handle the Ribbon Cable gently to avoid damage.

5. Lift the Control Board to remove.
6. Reverse for installation.

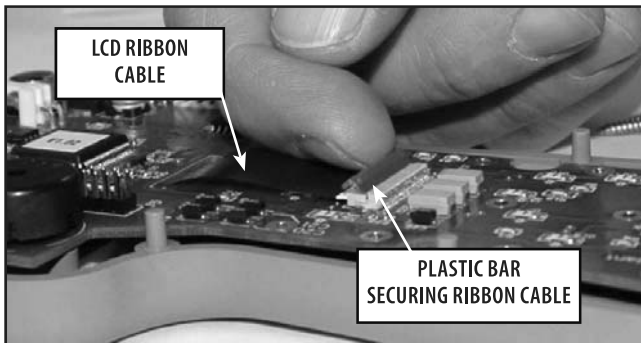

**FIGURE 6.23**

3. Disconnect the 2 Pin connector harness from the Display attached to the Control Board. **Refer to Figure 6.24.**

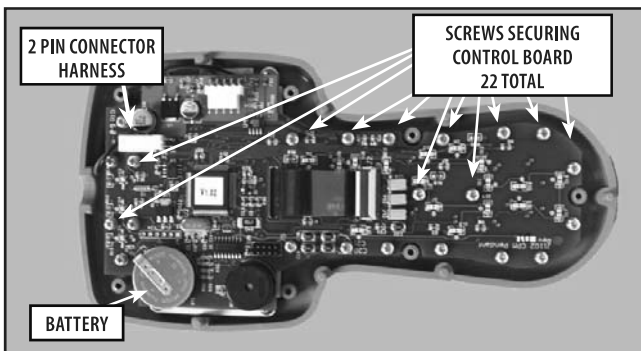

**FIGURE 6.24**

4. Using a #1 Phillip screwdriver, remove the 22 screw securing the Control Board to the Pendant Base. **Refer to Figure 6.24.**

## 6- REMOVAL & REPLACEMENT

### 6.12 PENDANT BATTERY

#### **WARNING**

Unplug the unit from the power source before attempting any removal or replacement procedures to prevent electrical shock.

**A. Part Number** .....89870

#### **B. Tools and Equipment Required**

- #1 Phillips Screwdriver
- Soldering Iron
- Solder

#### **C. Pendant Battery Removal & Replacement**

1. Refer to **Section 6.10, part C, Pendant Cable Removal and Replacement** to open the Pendant and remove the Cable.
2. Hold the sides of the Battery. While holding touch one of the solder points securing the Battery to the Control Board and lift to detach that side of the Battery from the Control Board. **Refer to Figure 6.25.**

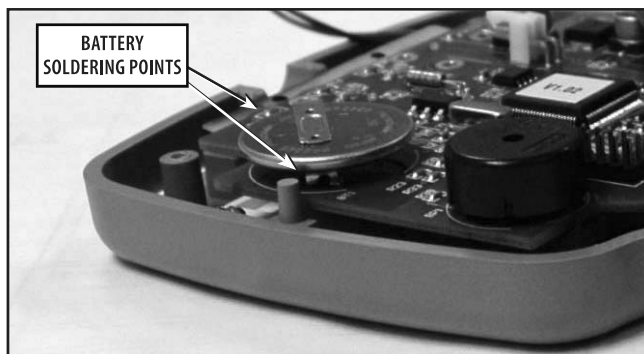

**FIGURE 6.25**

3. Repeat this process on the second solder point.
4. To install the Battery, use a soldering iron and solder to place a small bead of solder on each of the solder points on the Control Board.
5. Hold the Battery on the beads of solder placed on the Control Board.
6. Use a soldering iron to heat the beads of solder securing the Battery to the Control Board.

## 6- REMOVAL & REPLACEMENT

### 6.13 UPPER AND LOWER PENDANT KEYMATS

#### **WARNING**

Unplug the unit from the power source before attempting any removal or replacement procedures to prevent electrical shock.

#### A. Part Numbers

Upper Keymat .....J6100

Lower Keymat .....J6101

#### B. Tools and Equipment Required

- #1 Phillips Screwdriver

#### C. Upper and Lower Keymat Pendant Removal & Replacement

1. Refer to **Section 6.11, part C, Control Board Removal and Replacement** to open the Pendant, remove the Cable, and remove the Control Board.
2. Lift to remove the Keymat. **Refer to Figure 6.26.**

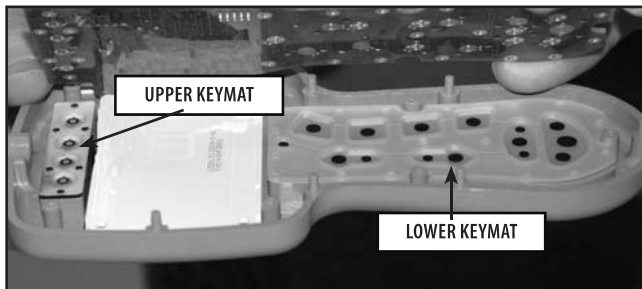

**FIGURE 6.26**

3. Reverse for installation.



## 6- REMOVAL & REPLACEMENT

### 6.14 PENDANT DISPLAY

#### **WARNING**

Unplug the unit from the power source before attempting any removal or replacement procedures to prevent electrical shock.

**A. Part Number** .....J1123

#### **B. Tools and Equipment Required**

- #1 Phillips Screwdriver

#### **C. Pendant Receptacle Cable Removal & Replacement**

1. Refer to **Section 6.11, part C, Control Board Removal and Replacement** to open the Pendant, remove the Cable, and remove the Control Board.
2. Using a #1 Phillips screwdriver, remove the 4 screws securing the Pendant Display to the Upper case of the Pendant. **Refer to Figure 6.27.**

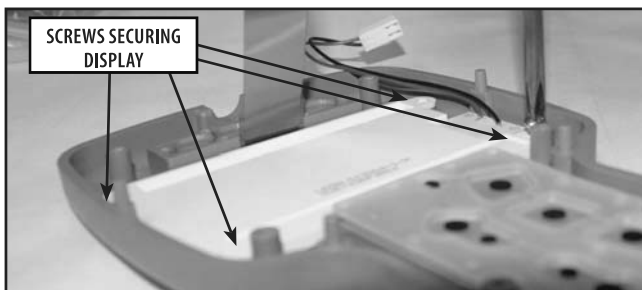

**FIGURE 6.27**

3. Lift the display to remove.
4. Reverse for installation.

## 7.1 ANGLE POTENTIOMETER POSITION CALIBRATION

The following procedure constitutes the required calibration of the Angle Potentiometer.

### A. Tools Required

- #2 Phillips Screwdriver
- Calibrated and certified Protractor with 1° accuracy or other angle measuring device calibrated with 1° accuracy
- Digital Multimeter
- Small Flathead Screwdriver
- 3/32" Allen Wrench
- Preset 5 inch-pound "T"-Handle Torque Wrench
- Tape Measure

### B. Potentiometer Decal and Cover Removal

#### NOTE:

Be careful not to damage decal. It will be used for installation after the calibration procedure is complete.

Refer to **Section 6.1, part C**, Rear Cover Removal and Replacement to remove the Rear Cover of the unit.

Using a small fine edged tool, carefully remove the Decal from the Potentiometer Cover. Refer to **Figure 7.1**.

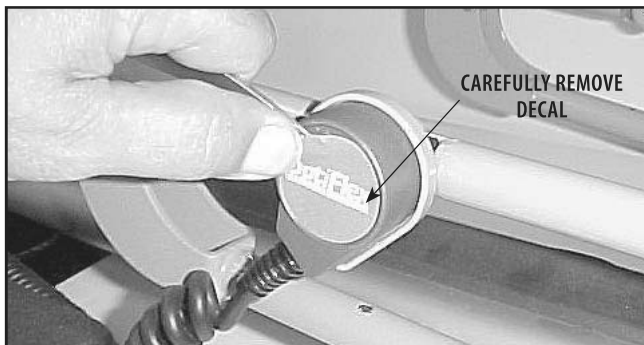



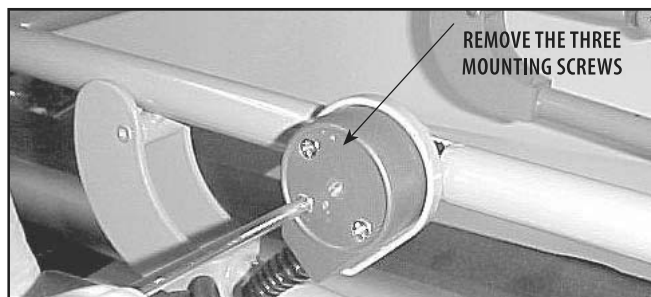

**FIGURE 7.1**

Using the #2 Phillips Screwdriver, remove the three Potentiometer cover mounting screws. Refer to **Figure 7.2**.



**FIGURE 7.2**

### C. Initial Position Calibration Procedure

1. Enter the "Calibration Mode" of the Pendant by pressing and holding the "Comfort Zone"  button.
2. While holding down the "Comfort Zone" button, press the following buttons in the sequence listed:
  - a. Progressive ROM 
  - b. Fast Back 
  - c. Oscillation Zone 
  - d. Mode 
3. Release the "Comfort Zone" button. "Calibration Mode Move to 0 deg." should be displayed at the bottom of the Pendant Display window. Refer to **Figure 7.3**.



**FIGURE 7.3**

4. Place the calibrated Protractor with 1° accuracy across the carriage and press the Up and Down Arrow button on the Pendant until the protractor reads zero. Refer to **Figure 7.4**.

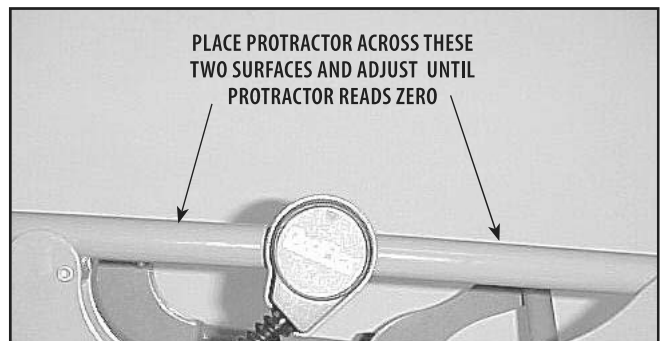

**FIGURE 7.4**

## 7.1 ANGLE POTENTIOMETER POSITION CALIBRATION (CONTINUED)

5. With the 3/32" Allen wrench, loosen the two set screws retaining the potentiometer. Refer to Figure 7.5.

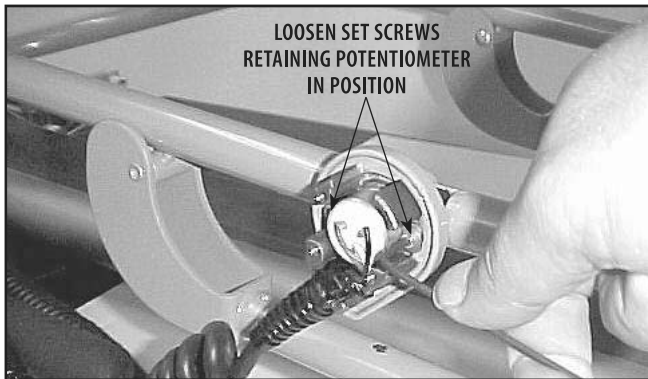

FIGURE 7.5

6. Connect the negative (black) lead from the Digital Multimeter to the Motor Control Board Mounting Bracket and the Positive (red) Lead to the Red Wire on the Potentiometer. Refer to Figure 7.6.

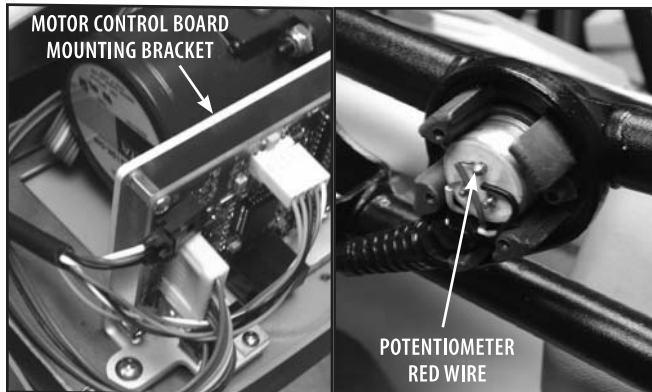

FIGURE 7.6

7. Rotate the Potentiometer by hand until a value between 1.018 Volts - 1.081 Volts is displayed on the Digital Multimeter. Refer to Figure 7.7.



FIGURE 7.7

8. Torque the two potentiometer set screws with the preset 5 inch-pound "T"-Handle Torque Wrench. Verify voltage. Refer to step 7.
9. Press the Extension button. This programs the zero position in the software.
10. Press the Up Arrow button until the front of the Carriage Guide Bar is approximately 1.250" (32 mm) from the cut out in the Front Cover. Refer to Figure 7.8.

### NOTE:

At any time during this process if the Carriage is moved too far, an Error Message may be display. It will then be necessary to manually move the Carriage by loosening the Femur Bar and raising it until the Carriage Guide Bar is approximately at 0° to cancel the Error. Once the Guide Bar is zeroed, turn the unit off to clear the error message.

If the Carriage is required to be manually moved, then it will be necessary to re-start the Initial Position Calibration Procedure. Refer to 7.1, part C.

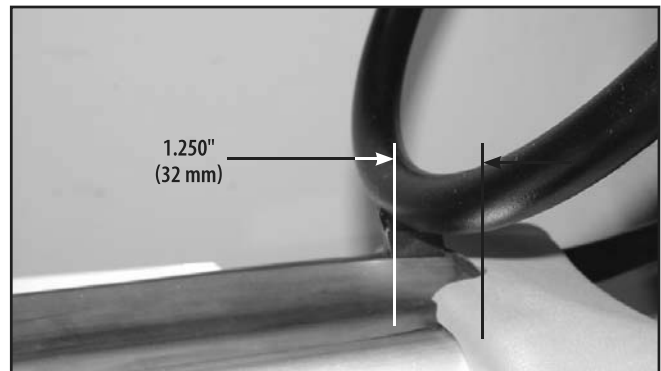

FIGURE 7.8

11. Press the Flexion button. This programs the upper limit position in the software.
12. Install the Potentiometer Cover and Decal.
13. Power unit off and on. This completes Potentiometer Position Calibration.
14. Perform **Force Reversal Calibration**, Section 7.2.

## DANGER



Failure to re-install and properly tighten all screws may result in Electrical Safety System degradation which may cause unit damage, malfunction, electrical shock or personal injury.

## 7.2 FORCE REVERSAL CALIBRATION

### A. Position Carriage

Move the carriage to a position of  $-5^{\circ}$  to  $-10^{\circ}$ .

### B. Set Unit to Force Reversal Calibration Mode

While holding down the "SPEED" button, press the following buttons in the sequence listed:

1. Progressive ROM 
2. Fast Back 
3. Oscillation zone 
4. Mode 
5. Release the Speed button.

"STAND BACK! Unit Self Calibrating" should be displayed at the bottom of the Pendant display and a Timer should begin counting down from approximately 30 sec. **Refer to Figure 7.10.**



**FIGURE 7.10**

6. After all movement of the unit has stopped, the Display will prompt the technician to turn the unit off and back on. **Refer to Figure 7.11.** This completes Force Reversal Calibration.

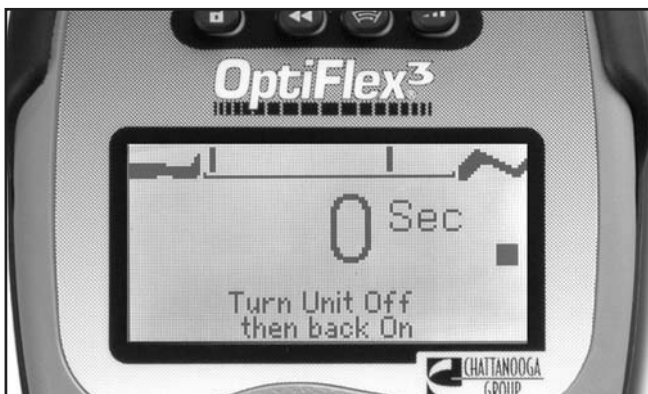

**FIGURE 7.11**

## **WARNING**

Unplug the unit from the power source before attempting any removal or replacement procedures to prevent electrical shock.

### **8.1 CLEANING THE SYSTEM**

With the system disconnected from the power source, clean the system with a clean, lint free cloth moistened with water and mild antibacterial soap. If a more sterile cleaning is needed, use a cloth moistened with an antimicrobial cleaner.

### **8.2 PREVENTIVE MAINTENANCE**

- A.** The OptiFlex<sup>3</sup> CPM unit should be placed on a regular maintenance, and inspection schedule based on the practices of the healthy care facility.
- B.** Inspect the OptiFlex<sup>3</sup> CPM unit thoroughly during scheduled maintenance and perform a functional inspection verifying the calibration and angle of the unit. Recommended Visual and Functional Inspection information can be found in sections 5.3 and 5.4 of Troubleshooting.

Inspection should be performed by a person qualified to recognize any signs of wear or tear, looseness of bolts, parts or inconsistencies in function.

### **8.3 FACTORY SERVICE**

When the OptiFlex<sup>3</sup> CPM unit requires factory service, contact the dealer or Chattanooga Group Service Department.

#### **WARRANTY REPAIR/OUT OF WARRANTY REPAIR**

- 1.** Written statement containing the following information:
  - RA Number- Obtain from Factory
  - System Model Number
  - System Serial Number
  - Contact Person with Phone and Fax Numbers
  - Billing Address (for Out of Warranty Repair)
  - Shipping Address (Where to Ship Unit after Repair)
  - Detailed Description of Problem or Symptoms
- 2.** Copy of original invoice issued at purchase of the System.
- 3.** Ship the unit to address specified by an authorized service technician.

Service to these units should be performed only by Service Technicians certified by Chattanooga Group.

**8.4 MAINTENANCE RECORDS**

---

---

---

---

---

---

---

---

---

---

---

---

---

---

---

---

---

---

---

---

---

---

---

---

---

---

---

---

---

---



# 9- PARTS

## 8.1 OPTIFLEX<sup>3</sup> CPM THERAPY UNIT- PARTS

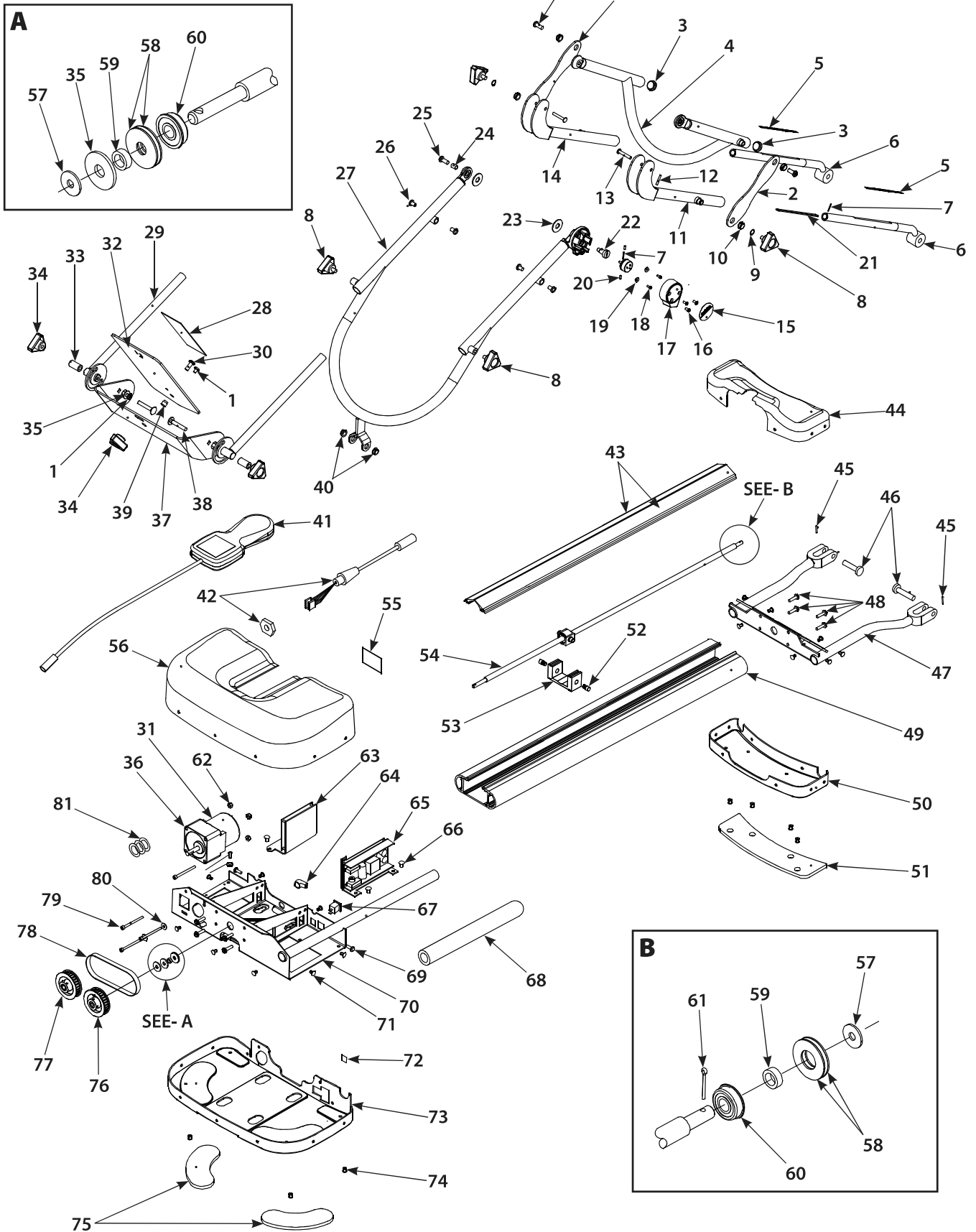



# 9- PARTS

## 9.1 OPTIFLEX<sup>3</sup> CPM THERAPY UNIT- PARTS LIST

ITEM	PART NO.	DESCRIPTION	QTY
1	62066	SCREW, 1/4-20 X 5/8"	5
2	J1117	FEMUR LINKAGE	2
3	65991	TUBE PLUG	2
4	J1114	THIGH S/A	1
5	J6091	DECAL, THIGH SCALE	2
6	J1086	WELDMENT TUBE	2
7	J6023	SPLIT PIN, 1/16" X 9/16"	2
8	J6012	KNOB, MALE 1/4"-20	4
9	J6051	SNAP RING	2
10	J6005	BEARING, SPLIT FLANGE	4
11	J1115	LEFT FEMUR HINGE	1
12	87898	SPLIT PIN, 1/8" X 3/4"	1
13	J6027	RIVET, FEMUR HINGE	2
14	J1118	RIGHT FEMUR HINGE	1
15	J6107	DECAL, POT	1
16	J6024	SCREW, #6-32 POT MOUNT	3
17	J6105	COVER, POT	1
18	J6002	SCREW, #4-40	2
19	J6003	SERVO MOUNT CLEAT	2
20	J6022	TUBE, POT PIN	1
21	J1063	FEMUR BAR CATCH	1
22	J1041	PIN, POT PIVOT	1
23	J6006	WASHER, .312 ID X 1" OD	2
24	J1061	SLEEVE, CARRIAGE PIVOT	1
25	J6007	SCREW, 1/4"-28 X 5/8"	1
26	21179	WASHER, NYLON	4
27	J1116	CALF S/A	1
28	J1067	VELCRO HOOK	1
29	J1036	FOOT ROD S/A	2
30	62066	SCREW, 1/4"-20 X 5/8"	5
31	21176	MOTOR, BRUSHLESS	1
32	J2014	FOOT PLATE	1
33	J6029	SPACER, NYLON FOOT	2
34	J6011	KNOB, FEMALE	3
35	J6044	WASHER	3
36	40100	GEAR BOX	1
37	J2013	FORMED FOOT PLATE	1
38	J6025	STOVE BOLT	2
39	J1071	PIN, FOOT ROTATION	1
40	J6001	BEARING, SPLIT FLANGE	2
41	J6087	PENDANT, OPTIFLEX 3 KIT	1
42	89852	PENDANT RECEPTACLE CABLE	1
43	J1025	WIPER	2
44	J6103	COVER, FRONT TOP	1

ITEM	PART NO.	DESCRIPTION	QTY
45	54931	PIN, SPLIT 3/32" X 5/8" PLT	2
46	J1089	CLEVIS PIN, 1/4" X 1-3/8" SS	2
47	J1131	WELDMENT, BASE FRAME	1
48	J6000	SCREW, #10-24 SELF TAP	8
49	J2003	EXTRUSION	1
50	J6104	COVER, FRONT BOTTOM	1
51	J1058	PAD, FRONT	1
52	J1055	PIN, TRUNION	2
53	J1034	SLIDER	1
54	J2004	ACME ROD	1
55	20993	DECAL, PENDANT REMOVAL	1
56	J6089	COVER, REAR TOP	1
57	J6064	WASHER, FLAT BEARING	2
58	J6009	BEARING, ROLLER	2
59	J1072	BUSHING, NYLON 3/8" OD	2
60	J6008	BEARING, FLANGE	2
61	J6035	PIN, COTTER	1
62	21733	NUT, #6-32 ESNA	4
63	J6088	BOARD, MOTOR CONTROL	1
64	J6065	STRAIN RELIEF	1
65	21267	POWER SUPPLY	1
66	71319	SCREW, #6-32 X 1/4"	5
67	J6058	SWITCH, ROCKER	1
68	68964	FOAM, HANDLE GRIP	1
69	53793	SCREW, #10 X 1/2" PAN TEK	2
70	J1111	BASE, REAR S/A	1
71	J6004	NYLON SNAP RIVET	19
72	J2030	DECAL, POWER OFF/ON	1
73	J6090	COVER, REAR BOTTOM	1
74	66058	RIVET	8
75	J1057	PAD, REAR	2
76	J2001	PULLEY, BALL SCREW	1
77	J2002	PULLEY, MOTOR	1
78	J2000	DRIVE BELT	1
79	J6048	SCREW, #8-32 X 2.0" SOC HD	4
80	70105	WASHER, #10 FLAT	3
81	J6054	O-RING	3
	J6040	KNEE POT CABLE (NOT ILLUSTRATED)	1

## 9- PARTS

### 9.2 OPTIFLEX<sup>3</sup> PENDANT- PARTS LIST

PART NO.	DESCRIPTION	QTY
J2038	PENDANT	1
J6094	UPPER PENDANT CASING	1
J6096	LOWER PENDANT CASING	1
J6100	PENDANT KEYMAT UPPER	1
J6101	PENDANT KEYMAT LOWER	1
J6106	DECAL OVERLAY PENDANT	1
J1119	SCREWS 2 X 5/16 PAN PHILLIPS	22
J1120	SCREWS 4 X 5/8 PAN PHILLIPS	7
J1121	O RING N 005	7
J6086	CABLE FOR THE PENDANT WITH RUBBER GASKET	1
J1123	PENDANT DISPLAY	1
J1124	SCREW 4-20 PLAS 3/16 PH PAN	4
89870	PENDANT BATTERY	1
J1068	VELCRO 2" BLK LOOP	1
J1102	PENDANT CONTROL BOARD	1

# 10- SCHEMATICS

## 10.1 BLOCK DIAGRAM (LANDSCAPED)

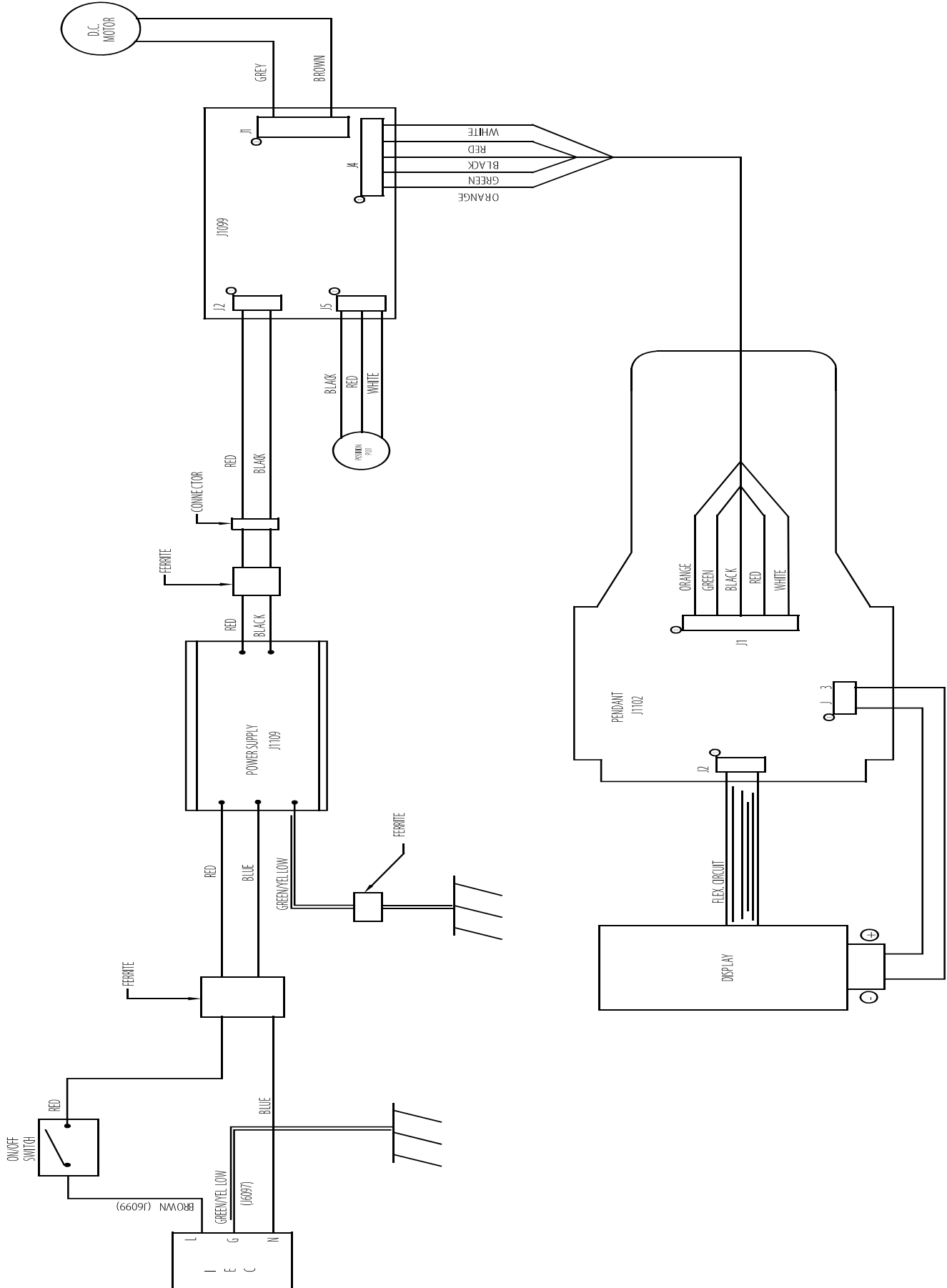

# 10- SCHEMATICS

## 10.2 CONTROL BOARD 1 (LANDSCAPED)

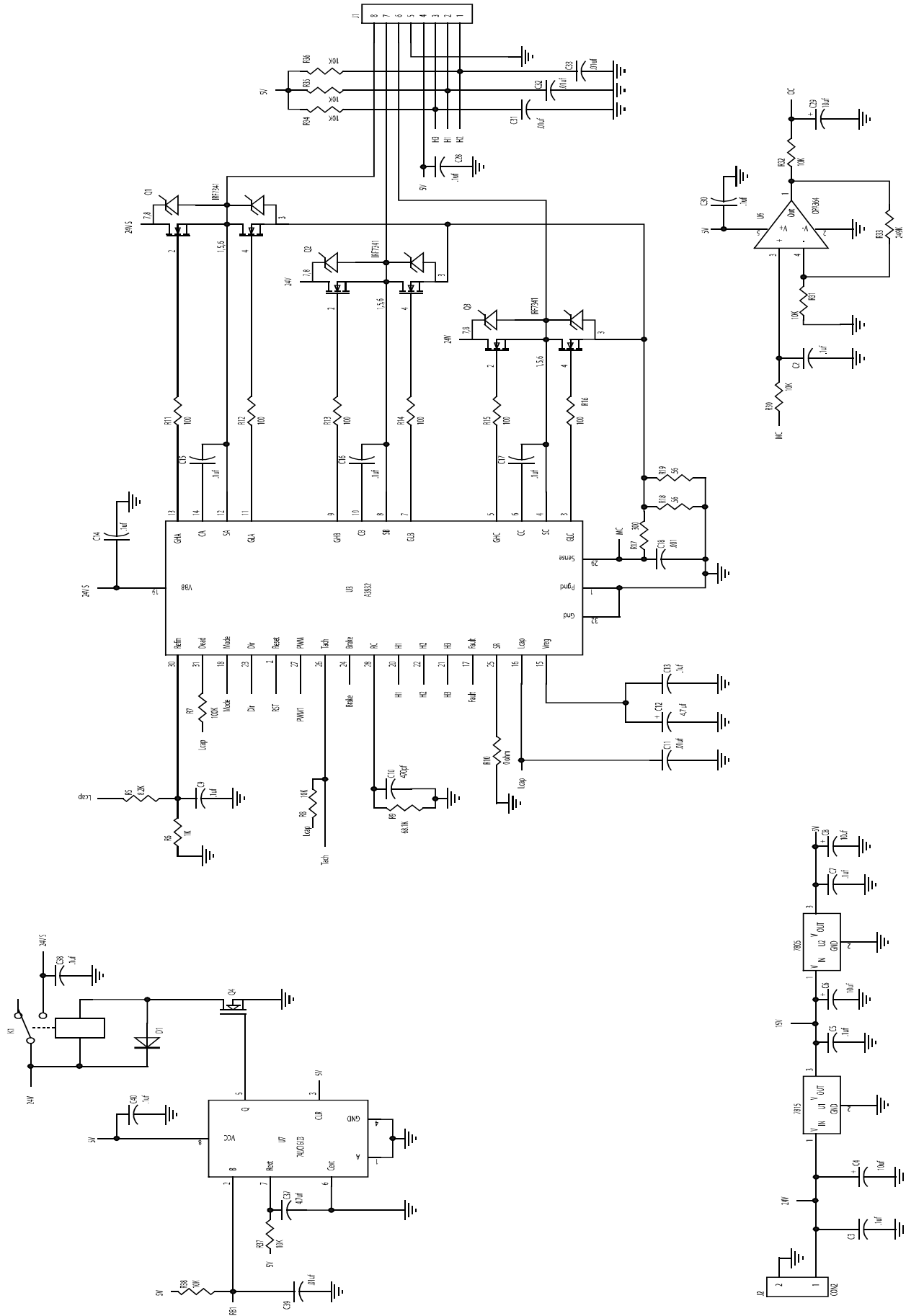

# 10- SCHEMATICS

## 10.2 CONTROL BOARD 2 (LANDSCAPED)

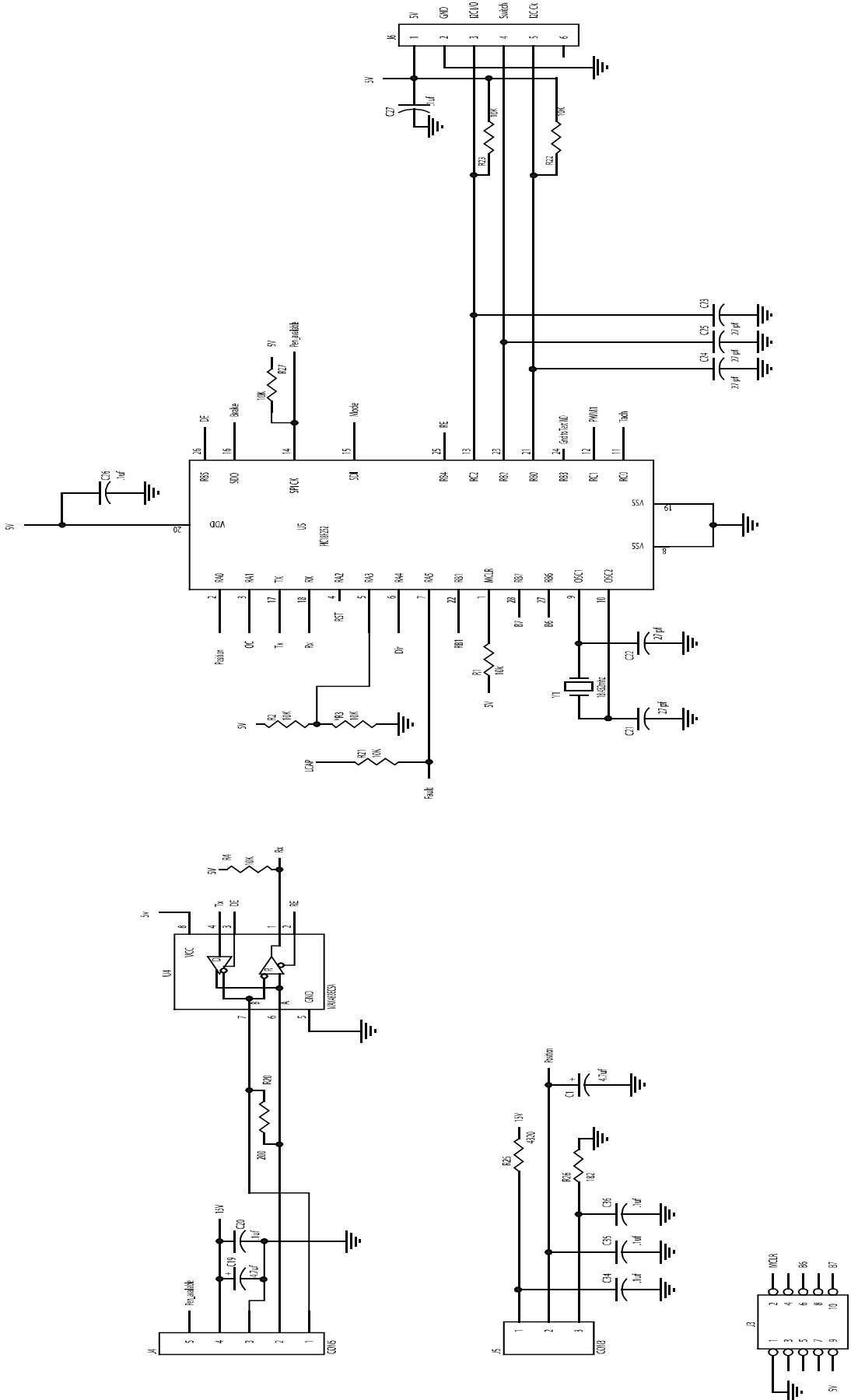

# 10- SCHEMATICS

## 10.2 PENDANT (LANDSCAPED)

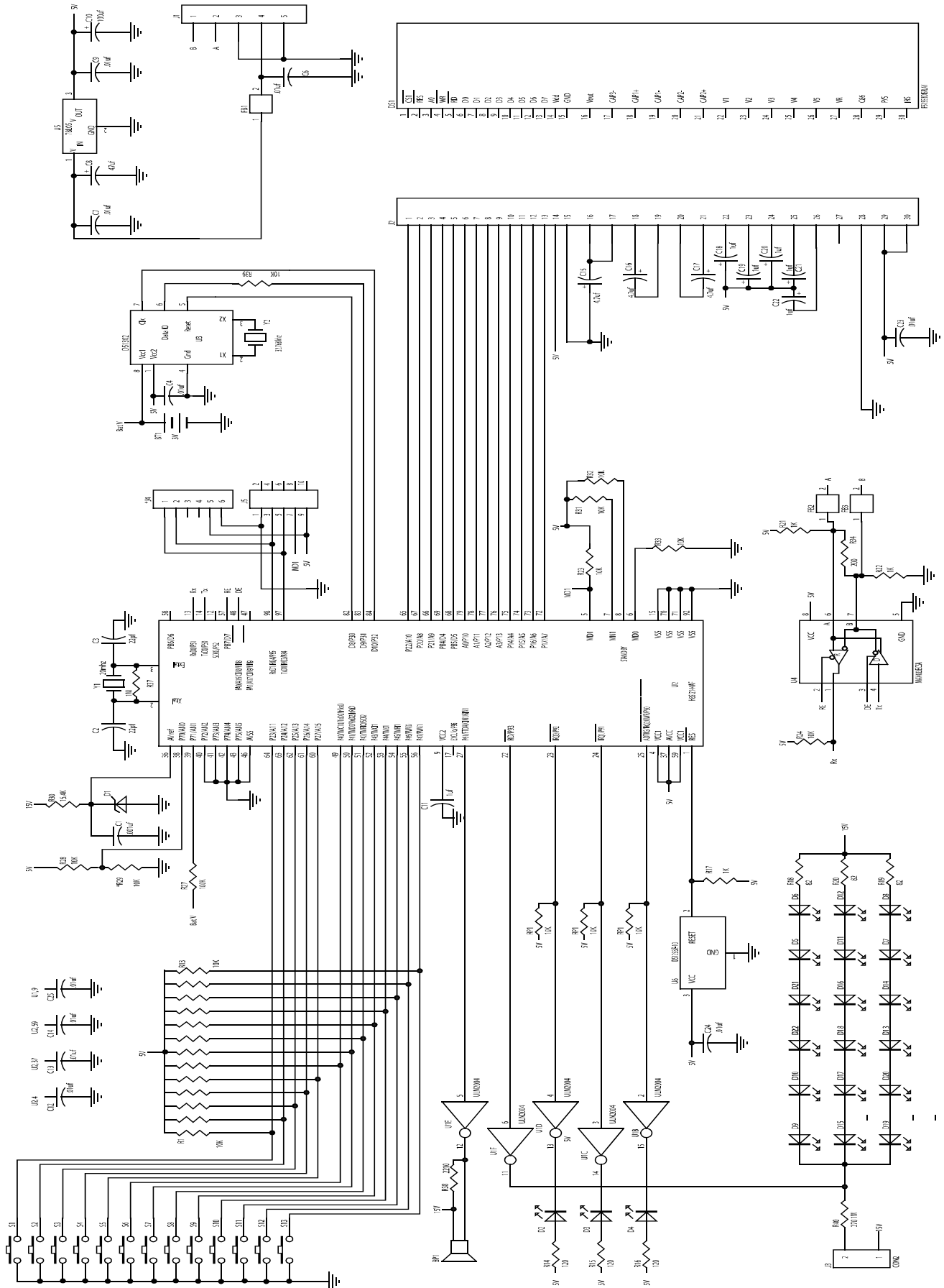

Chattanooga Group, a division of Encore Medical, L.P. ("Company") warrants that the OptiFlex<sup>3</sup> Continuous Passive Motion (CPM) therapy unit ("Product") is free of defects in material and workmanship. This warranty shall remain in effect for two years (24 months) from the date of original consumer purchase. If this Product fails to function during the two year warranty period due to a defect in material or workmanship, at the Company's option, the Company or the selling dealer will repair or replace this Product without charge within a period of thirty days from the date on which the Product is returned to the Company or the dealer.

All repairs to the Product must be performed by a service center authorized by the Company. Any modifications or repairs performed by unauthorized centers or groups will void this warranty.

The warranty period for accessories is thirty days. Accessories consist of the Patient Softgoods Kit shipped with the unit.

To participate in warranty coverage, this Product's warranty registration card (included with Product) must be filled out and returned to the Company by the original owner within ten business days of purchase.

### **This Warranty Does Not Cover:**

- Replacement parts or labor furnished by anyone other than the Company, the selling dealer, or a certified Company service agent.
- Defects or damage caused by labor furnished by someone other than the Company, the selling dealer, or a certified Company service agent.
- Any malfunction or failure in the Product caused by product misuse, including, but not limited to, the failure to provide reasonable and necessary maintenance or any use that is inconsistent with the Product User Manual.

### **COMPANY SHALL NOT BE LIABLE IN ANY EVENT FOR INCIDENTAL OR CONSEQUENTIAL DAMAGES.**

Some locations do not allow the exclusion or limitation of incidental or consequential damages, so the above limitation or exclusion may not apply to you.

To obtain service from Company or the selling dealer under this warranty:

1. A written claim must be made within the warranty period to the Company or the selling dealer. Written claims made to the Company should be sent to:

4717 Adams Road  
P.O. Box 489  
Hixson, TN 37343 USA  
Phone: USA: (800) 592-7329  
Fax: (423) 875-5497  
Canada: (800) 361-6661  
Outside USA: +1 (423) 870-7200  
Outside USA Fax: +1 (423) 870-2046

2. The Product must be returned to the Company or the selling dealer by the owner.

This warranty gives you specific legal rights and you may also have other rights which vary from state to state or location to location.

The Company does not authorize any person or representative to create for it any other obligation or liability in connection with the sale of the Product. Any representation or agreement not contained in the warranty shall be void and of no effect.

**THE FOREGOING WARRANTY IS IN LIEU OF ALL OTHER WARRANTIES, EXPRESSED OR IMPLIED, INCLUDING ANY WARRANTY OR MERCHANTABILITY OR FITNESS FOR A PARTICULAR PURPOSE.**

**Moving  
Rehabilitation  
Forward™**



MDSS GMBH

Schiffgraben 41

30175 Hanovre

Allemagne

Telephone: + 49 -511-6262-8630

Fax: + 49 -511-6262-8633



**ISO 13485 CERTIFIED**

4717 Adams Road

P.O. Box 489

Hixson, TN 37343 U.S.A.

1-423-870-2281

1-800-592-7329 U.S.A.

1-800-361-6661 CANADA

+1-423-870-7200 OUTSIDE U.S.A.

+1 423-870-2046 OUTSIDE U.S.A. FAX

chattgroup.com